



MOBILIER/2026  
OUTDOOR FURNITURE

**LES JARDINS<sup>®</sup>**  
AIX-EN-PROVENCE

OUTDOOR FURNITURE & SOLAR LIGHTING DESIGNER



**Singulier. Intemporel. Essentiel.**

Chaque collection raconte une histoire. Celle de 2026 s'inscrit dans une nouvelle étape de notre évolution : celle d'un mobilier d'extérieur qui conjugue le caractère unique du geste et la précision de l'industrie. Nos pièces naissent de cette rencontre entre le savoir-faire artisanal, ancré dans la matière, dans la main et la rigueur des procédés contemporains qui garantissent justesse, durabilité et cohérence.

Plus que des objets, nos créations cherchent à traverser le temps. Elles refusent l'éphémère pour mieux révéler l'intemporel. Formes sobres, détails maîtrisés, textures sincères : chaque collection affirme une singularité assumée, une élégance qui ne cède pas aux modes.

C'est dans cet équilibre entre tradition et innovation que se dessine l'esprit de notre maison : une vision du mobilier d'extérieur faite de sens, de justesse et de permanence.

**Singular. Timeless. Essential.**

Every collection tells a story. The 2026 edition marks a new chapter in our evolution: a vision of outdoor furniture that unites the unique character of craftsmanship with the precision of industry. Each piece is born from this meeting point, where artisanal know-how, rooted in material and hand, converges with the rigor of contemporary processes that ensure accuracy, durability, and consistency.

More than mere objects, our creations are designed to transcend time. They reject the ephemeral to better reveal the timeless. Pure lines, refined details, honest textures, each collection asserts a distinct identity, an elegance that stands apart from trends.

It is within this balance between tradition and innovation that the spirit of our house takes shape: a vision of outdoor furniture defined by meaning, precision, and permanence.

**LES JARDINS°**  
AIX-EN-PROVENCE

# Engagements

Depuis 1990, nous avons pris trois engagements principaux pour améliorer notre offre.

## Design et responsabilité

Bien que la plupart de nos produits en teck ne soient pas fabriqués en France, nous nous efforçons d'adopter des pratiques éco-responsables :

- Notre teck massif de plantation provient d'Indonésie et est issu de forêts certifiées, en culture raisonnée.
- Nous privilégions les fournisseurs français ou européens autant que possible.
- Nous demandons à nos fournisseurs de garantir des conditions de travail et des salaires conformes aux normes, souvent supérieurs à la moyenne.

## Confort et durabilité

Nous croyons en la durabilité de nos produits. 80% de nos articles sont démontables et réparables, ce qui permet de prolonger leur durée de vie et de réduire la surconsommation. C'est une petite contribution de notre part.

Nous vous encourageons à nous contacter pour prolonger la vie de vos meubles !



# Commitments

Since 1990, we have made three main commitments to improve our offering.

## Design and responsibility

Although most of our teak products are not made in France, we strive to adopt eco-responsible practices:

- Our plantation solid teak comes from Indonesia and is sourced from certified, sustainable forests.
- We prefer French or European suppliers wherever possible.
- We ask our suppliers to guarantee working conditions and wages that comply with standards and are often higher than average.

## Comfort and durability

We believe in the durability of our products. 80% of our products can be disassembled and repaired, extending their lifespan and reducing over-consumption.

It's a small contribution on our part.

We encourage you to contact us to extend the life of your furniture!



**LES JARDINS**  
AIX-EN-PROVENCE

## Collections 2025 / 2026



**Halo** p/10



**Cadix** p/16



**Chester** p/20



**Skaal** p/34



**Copenhagen** p/52



**Barrel** p/70



**Mira** p/76



**Selva** p/80



**Jet Stream** p/86



**Bastingage** p/98



**Rancho** p/116



**Amaka** p/126

## Collections 2025 / 2026

# Collections 2025 / 2026



Sagamore & Koton p/134



Yolo p/140



Bistro p/27 / 44 / 68 / 74 / 110 / 142 / 151



Tekura p/144

Kiosques p 154 / Douches Showers p 156 /

Parasols Umbrella p 158 / Coffres Cushion box p 170 /

Tapis Carpet p 171 / Housses de protection

Protection covers p 172 / Matériaux Materials p 174 /

Explorez nos collections  
& inspirez-vous !

Explore our collections and get inspired!

Application LES JARDINS®3D  
à télécharger sur mobile

LES JARDINS®3D application to download on mobile



Tarif valable du 1<sup>er</sup> septembre 2025 au 31 août 2026 / Price list valid from September 1, 2025 to August 31, 2026

# HALO

Épurées et élégantes, les tables lumineuses de la collection HALO transforment les terrasses. Elles brillent autant de jour que de nuit, offrant une esthétique à la fois sophistiquée et intemporelle.

Sleek and elegant, the light tables in the HALO collection transform terraces. They shine as brightly by day as they do by night, offering a sophisticated yet timeless aesthetic.





# HALO TABLES LUMINEUSES SOLAIRES ET RECHARGEABLES

TABLE SOLAR AND RECHARGEABLE LIGHTING

ECLAIRAGE  
500 LUMENS  
BRIGHT  
2700 K



TABLE DE REPAS HALO x 12/14  
HALO DINING TABLE

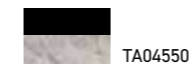

Aluminium noir,  
céramique Salika  
Black aluminum,  
Salika ceramic top

1pc/4boxes 1,85 m<sup>3</sup>  
142,10 kg



TABLE BASSE LUMINEUSE SOLAIRE ET RECHARGEABLE HALO  
HALO LOW TABLE SOLAR AND RECHARGEABLE LIGHTING



Aluminium gris espace,  
HPL céramique grise,  
plaque en verre dépoli acrylique  
Space grey aluminum, HPL grey  
ceramic top, acrylic frosted glass plate

1pc/2boxes 0,135 m<sup>3</sup>  
5,60 kg



Aluminium couleur Corten,  
HPL céramique lin,  
plaque en verre dépoli acrylique  
Corten color aluminum, HPL linen  
ceramic top, acrylic frosted glass plate

TABLE BASSE LUMINEUSE SOLAIRE ET RECHARGEABLE HALO  
HALO LOW TABLE SOLAR AND RECHARGEABLE LIGHTING



Aluminium gris espace,  
HPL céramique grise,  
plaque en verre dépoli acrylique  
Space grey aluminum, HPL grey  
ceramic top, acrylic frosted glass plate

1pc/3boxes 0,350 m<sup>3</sup>  
9,85 kg



Aluminium couleur Corten,  
HPL céramique lin,  
plaque en verre dépoli acrylique  
Corten color aluminum, HPL linen  
ceramic top, acrylic frosted glass plate

# HALO

TABLES LUMINEUSES  
SOLAIRES ET RECHARGEABLES

ECLAIRAGE  
500  
LUMENS  
BRIGHT  
2700 K

TABLE SOLAR AND RECHARGEABLE LIGHTING



TABLE DE REPAS LUMINEUSE HALO  
HALO DINING TABLE LIGHTING



TA04532

Aluminium blanc, HPL béton ciré,  
plaque en verre dépoli acrylique,  
base granite  
White aluminum, white wash concrete  
HPL, acrylic frosted glass plate,  
granit base



TA04530

Aluminium gris espace, HPL ardoise,  
plaque en verre dépoli acrylique,  
base granite  
Space grey aluminum, slat grey HPL,  
acrylic frosted glass plate,  
granit base

1pc/4boxes 0,627 m<sup>3</sup>  
47,80 kg



MANGE-DEBOUT LUMINEUX HALO  
HALO HIGH DINING LIGHTING

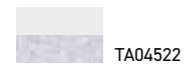

TA04522

Aluminium blanc, HPL béton ciré,  
plaque en verre dépoli acrylique,  
base granite  
White aluminum, white wash concrete  
HPL, acrylic frosted glass plate,  
granit base



TA04520

Aluminium gris espace, HPL ardoise,  
plaque en verre dépoli acrylique,  
base granite  
Space grey aluminum, slat grey HPL,  
acrylic frosted glass plate,  
granit base

1pc/4boxes 0,76 m<sup>3</sup>  
45,5 kg



# CADIX



Les tables CADIX, avec leur éclairage vibratoire chaleureux, apportent une touche de modernité jour et nuit. Le design torsadé de leurs piètements en aluminium ajoute une note distinctive à leur allure.

CADIX tables, with their warm, vibrating lighting, add a modern touch day and night. The twisted design of their aluminum legs adds a distinctive touch to their look.

# CADIX

TABLES LUMINEUSES  
SOLAIRES ET RECHARGEABLES

TABLES SOLARS AND RECHARGEABLES LIGHTING

ECLAIRAGE  
**500**  
LUMENS  
BRIGHT  
**2700 K**



TABLE DE REPAS LUMINEUSE CADIX  
CADIX DINING TABLE LIGHTING



Aluminium blanc, HPL béton ciré,  
plaque en verre dépoli acrylique,  
granite  
White aluminum, white wash concrete  
HPL, acrylic frosted glass plate, granite

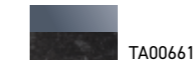

Aluminium gris espace, HPL ardoise,  
plaque en verre dépoli acrylique,  
granite  
Space grey aluminum, slat grey HPL,  
acrylic frosted glass plate, granite

1pc/4boxes 0,419 m<sup>3</sup>  
42,15 kg



MANGE-DEBOUT LUMINEUX CADIX  
CADIX HIGH DINING LIGHTING



Aluminium blanc, HPL béton ciré,  
plaque en verre dépoli acrylique,  
granite  
White aluminum, white wash concrete  
HPL, acrylic frosted glass plate, granite

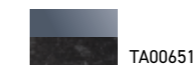

Aluminium gris espace, HPL ardoise,  
plaque en verre dépoli acrylique,  
granite  
Space grey aluminum, slat grey HPL,  
acrylic frosted glass plate, granite

1pc/4boxes 0,476 m<sup>3</sup>  
40 kg

# CHESTER

Design by Claude Robin  
Design by 2x5 Design



CHESTER, notre nouvelle collection fusionne habilement savoir-faire artisanal et matériaux contemporains. Réalisés en teck massif à la finition Duratek®, ces meubles allient élégance et durabilité sans entretien. Les fauteuils, avec leur dossier tissé à la main et agrémentés de boutons, apportent une touche moderne. Les tables basses s'assemblent harmonieusement pour créer des espaces lounge accueillants.

CHESTER, our new collection, skillfully blends artisanal craftsmanship with contemporary materials. Made from solid teak with a Duratek® finish, these pieces combine elegance and maintenance-free durability. The armchairs, featuring handwoven backs adorned with buttons, bring a modern touch. The coffee tables come together harmoniously to create inviting lounge spaces.





# CHESTER

TABLE DE REPAS EN TECK MASSIF À LA FINITION DURATEK®  
 DURATEK® FINISH SOLID TEAK DINNING TABLE



Existe aussi en céramique Belgium anthracite  
 Also available in Belgium anthracite ceramic



TABLE DE REPAS OVALE CHESTER x 12/14  
 CHESTER OVAL DINING TABLE



PT01501/P1

Teck massif à la finition Duratek®,  
 Céramique pierre naturelle  
 Duratek® finish solid teak,  
 Silk stone white ceramic



PT01501/P2

Teck massif à la finition Duratek®,  
 Céramique belgium anthracite  
 Duratek® finish solid teak,  
 Belgium dark grey ceramic

1pc/3boxes

1,074 m³

134,20 kg



120 cm / 47.24"



340 cm / 133.8"

# CHESTER

## TABLE DE REPAS, FAUTEUIL ET TABOURET

DINNING TABLE, ARMCHAIR AND BAR STOOL



TABLE EXTENSIBLE PAR SYSTÈME DE LEVIER x 10/12  
TABLE EXTENDING WITH LEVER SYSTEM

**TA03141**  
Aluminium Duratek®,  
céramique pierre naturelle  
Duratek® aluminum,  
Silk stone ceramic  
1pc/2boxes 0,794 m<sup>3</sup>  
91 kg



TABOURET CHESTER  
CHESTER BAR STOOL

**TAB5511** Aluminium blanc, Câbles inox 316  
White aluminum, Stainless cables 316  
**TAB5514** Aluminium noir, Câbles inox 316  
Black aluminum, Stainless cables 316  
**TAB5510** Aluminium gris espace, Câbles inox 316  
Space grey aluminum, Stainless cables 316  
**TAB5513** Aluminium vert avocat, Câbles inox 316  
Green avocado aluminum, Stainless cables 316  
**TAB5515** Aluminium Duratek®, Câbles inox 316  
Duratek® aluminum, Stainless cables 316  
**TAB5512** Aluminium couleur Corten, Câbles inox 316  
Corten color aluminum, Stainless cables 316  
1pce/1box 0,39 m<sup>3</sup>  
5 kg

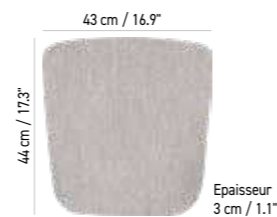

COUSSIN ASSISE CHESTER POUR TABOURET  
CHESTER SEAT CUSHION FOR STOOL

**COG5510\***  
Ateja La concha taupe chiné,  
heaver taupe La concha Ateja  
1pce/1box 0,002 m<sup>3</sup>  
0,35 kg

\* Ces produits sont disponibles sur commande. These products are available to order.



FAUTEUIL EMPILABLE CHESTER  
STACKABLE CHESTER ARMCHAIR

**FA05511** Aluminium blanc, Câbles inox 316  
White aluminum, Stainless cables 316  
**FA05514** Aluminium noir, Câbles inox 316  
Black aluminum, Stainless cables 316  
**FA05510** Aluminium gris espace, Câbles inox 316  
Space grey aluminum, Stainless cables 316  
**FA05513** Aluminium vert avocat, Câbles inox 316  
Green avocado aluminum, Stainless cables 316  
**FA05515** Aluminium Duratek®, Câbles inox 316  
Duratek® aluminum, Stainless cables 316  
4pces/1box 0,142 m<sup>3</sup>  
5,6 kg  
**FA05512** Aluminium couleur Corten, Câbles inox 316  
Corten color aluminum, Stainless cables 316

COUSSIN ASSISE CHESTER POUR FAUTEUIL  
CHESTER SEAT CUSHION FOR DINING ARMCHAIR

**COG5511\***  
Ateja La concha taupe chiné,  
heaver taupe La concha Ateja  
1pce/1box 0,002 m<sup>3</sup>  
0,400 kg



MANGE DEBOUT CHESTER\*  
CHESTER HIGH DINING

**PTC5511/P1** Céramique belgium anthracite, aluminium noir, pied latté avocat, base granite noir  
Ceram belg dark grey top, black aluminum, leg avocado slats, granit base  
1pce/3boxes 0,426 m<sup>3</sup>  
53,31 kg  
**PTC5510/P1** Céramique belgium anthracite, aluminium noir, pied latté noir, base granite noir  
Ceram belg dark grey top, black aluminum, leg black slats, granit base

TABLE BISTRO CHESTER\*  
CHESTER BISTRO TABLE

**PTC5501/P1** Céramique belgium anthracite, aluminium noir, pied latté avocat, base granite noir  
Ceram belg dark grey top, black aluminum, leg avocado slats, granit base  
1pce/3boxes 0,393 m<sup>3</sup>  
50,90 kg  
**PTC5500/P1** Céramique belgium anthracite, aluminium noir, pied latté noir, base granite noir  
Ceram belg dark grey top, black aluminum, leg black slats, granit base

\* Ces produits sont disponibles sur commande. These products are available to order.



DAYBED CHESTER  
 AVEC 4 COUSSINS DÉCO  
 CHESTER DAYBED  
 WITH FOUR DECO CUSHIONS



Teck massif à la finition Duratek®,  
 Ateja La concha taupe chiné,  
 Wicker, aluminium bronze  
 Duratek® finish solid teak, heaver  
 taupe La concha Ateja,  
 Wicker, bronze aluminum

1pc/1box 2,073 m<sup>3</sup>  
 56,9 kg



# CHESTER

## CANAPÉ, FAUTEUIL, TABLE BASSE ET COUSSIN

SOFA, ARMCHAIR, LOW TABLE AND CUSHION



CANAPÉ 3 PLACES CHESTER x 3/4  
CHESTER 3 SEATS SOFA



Teck massif à la finition Duratek®,  
Ateja La concha taupe chiné,  
Wicker, aluminium bronze  
Duratek® finish solid teak,  
heaver taupe La concha Ateja,  
Wicker, bronze aluminum

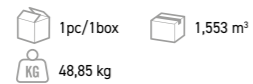

CANAPÉ 2 PLACES CHESTER x 2/3  
CHESTER 2 SEATS SOFA

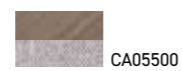

Teck massif à la finition Duratek®,  
Ateja La concha taupe chiné,  
Wicker, aluminium bronze  
Duratek® finish solid teak,  
heaver taupe La concha Ateja,  
Wicker, bronze aluminum

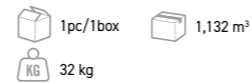

FAUTEUIL CLUB CHESTER  
CHESTER CLUB ARMCHAIR



Teck massif à la finition Duratek®,  
Ateja La concha taupe chiné,  
Wicker, aluminium bronze  
Duratek® finish solid teak,  
heaver taupe La concha Ateja,  
Wicker, bronze aluminum

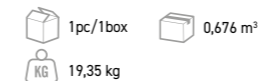
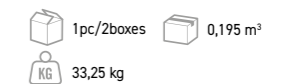

TABLE BASSE OVALE CHESTER  
CHESTER OVAL LOW TABLE



Teck massif  
à la finition Duratek®,  
Céramique pierre naturelle  
Duratek® finish solid teak,  
Silk Stone white ceramic



HOUSSE DE PROTECTION  
PROTECTION COVER  
HP05501



COUSSIN KOMO  
KOMO CUSHION



Coussin déco rafia x1  
Deco cushion rafia

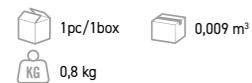

HOUSSE DE PROTECTION  
PROTECTION COVER  
HP05500

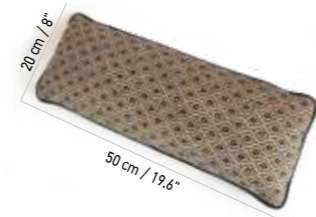

COUSSIN CALE DOS KOMO  
KOMO BACK CUSHION



Coussin déco rafia x1  
Deco cushion rafia

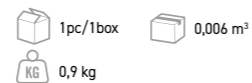

HOUSSE DE PROTECTION  
PROTECTION COVER  
HP05502



TABLE BASSE CHESTER  
CHESTER LOW TABLE



Teck massif à la finition Duratek®,  
Céramique pierre naturelle  
Duratek® finish solid teak,  
Silk Stone white ceramic

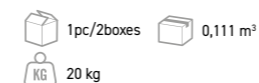

+ Duratek® : notre teck massif sans entretien / our maintenance-free solid teak



TABLE BASSE CHESTER  
CHESTER LOW TABLE



Teck massif à la finition Duratek®,  
Céramique pierre naturelle  
Duratek® finish solid teak,  
Silk Stone white ceramic

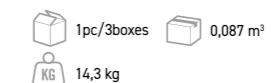

# CHESTER

## CANAPÉ, FAUTEUIL, TABLE BASSE ET COUSSIN

SOFA, ARMCHAIR, LOW TABLE AND CUSHION



FAUTEUIL BAS ROTATIF 360° SELVA  
SELVA SWIVEL SYSTEM CLUB ARMCHAIR



Aluminium Duratek®, Ateja La concha taupe chiné,  
corde plate grège chiné  
Duratek® aluminium, heaver taupe La concha Ateja,  
Greige mottled flat rope

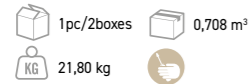

TABLE BASSE CHESTER  
CHESTER LOW TABLE



Teck massif à la finition Duratek®,  
plateau céramique pierre naturelle  
Duratek® finish solid teak,  
Silk stone ceramic top



FAUTEUIL BAS SMALL CHESTER  
CHESTER LOW ARMCHAIR SMALL



Teck massif à la finition Duratek®,  
Ateja La concha taupe chiné,  
Wicker, aluminium bronze  
Duratek® finish solid teak,  
heaver taupe La concha Ateja,  
Wicker, bronze aluminum

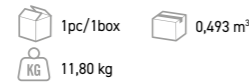
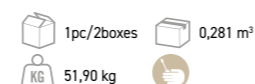

TABLE BASSE CHESTER  
CHESTER LOW TABLE



Teck massif  
à la finition Duratek®,  
plateau céramique pierre naturelle  
Duratek® finish solid teak,  
Silk stone ceramic top



BAIN DE SOLEIL CHESTER EMPILABLE, ROUES ARRIÈRES  
CHESTER STACKABLE SUNLOUNGER, BACKWHEELS



Aluminium Duratek®,  
toile Moka chiné  
Duratek® aluminum,  
Moka mottled sling



TABLE BASSE EMPILABLE CHESTER  
CHESTER LOW TABLE STACKABLE



Aluminium Duratek®,  
céramique pierre naturelle  
Duratek® aluminum,  
Silk stone ceramic top



COUSSIN POUR BAIN DE SOLEIL  
CUSHION FOR SUNLOUNGER



Ateja La concha taupe chiné  
heaver taupe La concha Ateja

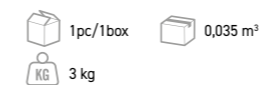



# SKAAL

Design by Claude Robin



Une ligne complète de mobilier cossu et de grand confort. Son charme réside dans ses couleurs très contemporaines et ses lignes asymétriques. Déjà un classique !  
Modern and comfortable. SKAAL's asymmetrical lines bring the final touch to your outdoor oasis.

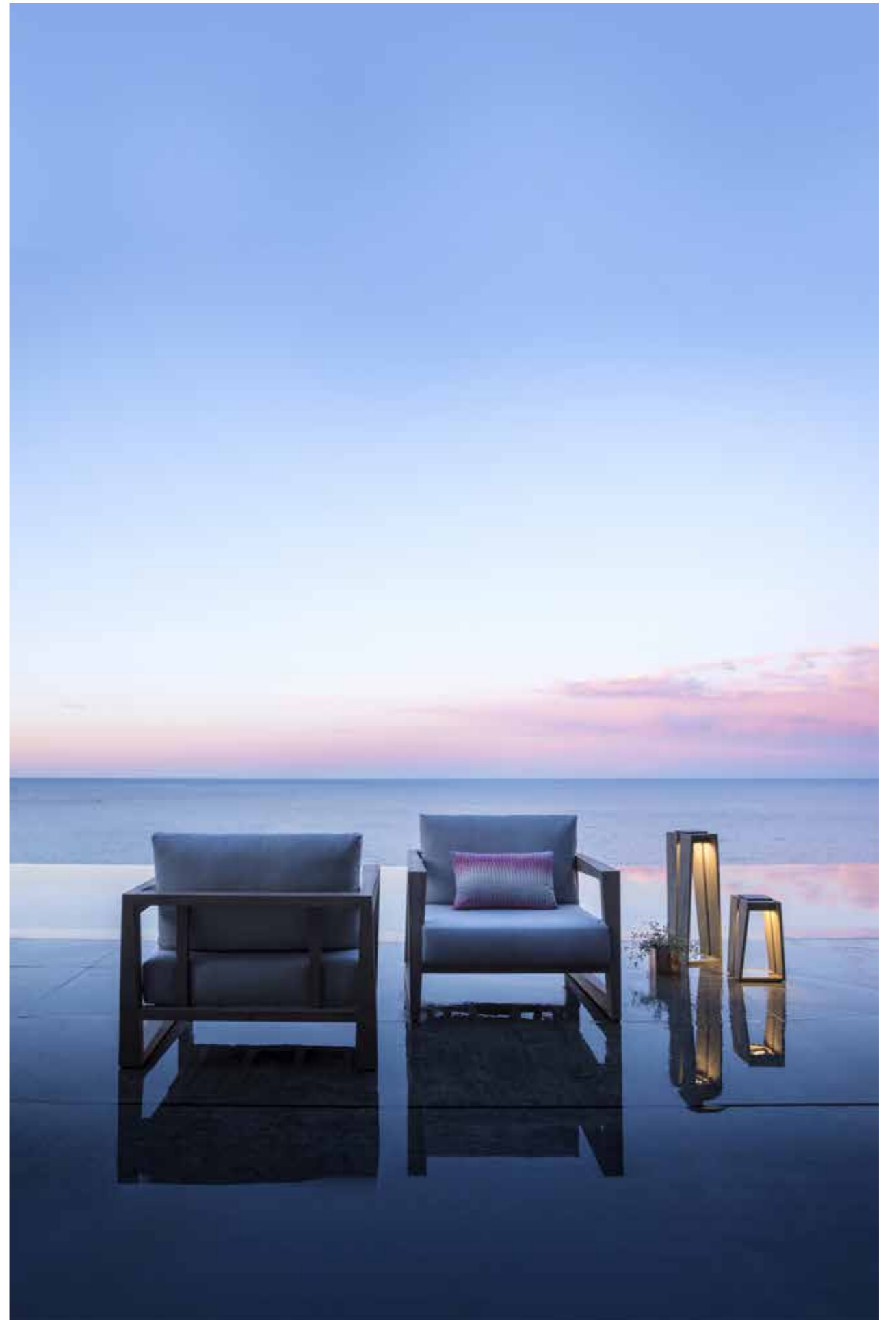



Lopi marble  
Marble lopi







Matières : Teck massif à la finition Duratek® sans entretien, céramique italienne, coussinage Sunbrella®, toile Batyline Eden, HPL finition béton ciré.

Entretien : Le Duratek® ne nécessite pas d'entretien et peut rester dehors toute l'année sans altération de sa couleur, il en va de même pour la toile Batyline. Les coussins sont déperlants mais doivent être hivernés. Nous conseillons de nettoyer le plateau des tables en HPL ou céramiques après chaque repas à l'eau savonneuse ou au nettoyant pour vitres. Ne pas utiliser de produits abrasifs pour l'entretien du Duratek®.

Materials: Solid teak Duratek® finish with no maintenance, Italian ceramics, Sunbrella® cushions, Eden Batyline, White wash concrete HPL.

Maintenance: The Duratek® doesn't need maintenance, it can stay outside all year long, just like the Batyline sling chairs. Cushions are water repellent, but need to be stored in winter. It is advisable to clean up the table HPL or ceramic tops after each meal. Do not use abrasive products to clean Duratek®/frames.





TABLE EXTENSIBLE SKAAL x 10/12  
PAR SYSTEME DE LEVIER  
EXTENDABLE TABLE SKAAL WITH LEVER SYSTEM

- |   |  |   |                                  |
|---|--|---|----------------------------------|
| TA04050/P1<br>Céramique marbre noir<br>Ceramic marble black | TA04050/P2<br>Céramique blanche tadelakt<br>Ceramic white tadelakt | TA04050/P3<br>Céramique béton ciré<br>Ceramic white polished concrete | 1pc/2boxes  0,802 m³<br>97,50 kg |
|---|--|---|----------------------------------|

Céramique italienne / Italian ceramics + Duratek®: notre teck massif sans entretien / our maintenance-free solid teak



FAUTEUIL EMPILABLE SKAAL  
SKAAL STACKABLE ARMCHAIR

- FA02316Y  
Toile tissée grafito  
Grafito woven canvas
- 2pcs/1box 0,224 m³  
 5,5 kg



TABLE HPL BISTRO SKAAL x 2  
SKAAL HPL BISTRO TABLE

- TA02289  
HPL béton ciré  
white wash concrete HPL
- TA02294  
HPL ardoise  
slate grey HPL
- 1pc/1box 0,071 m³  
 18,5 kg



TABLE CARRÉE PIED CENTRAL SKAAL x 2/4  
SKAAL CENTRAL FEET DINING TABLE

- |   |  |   |                                 |
|---|--|---|---------------------------------|
| TA04058/P1<br>Céramique marbre noir<br>Ceramic marble black | TA04058/P2<br>Céramique blanche tadelakt<br>Ceramic white tadelakt | TA04058/P3<br>Céramique béton ciré<br>Ceramic white polished concrete | 1pc/3boxes  0,19 m³<br>33,50 kg |
|---|--|---|---------------------------------|



TABLE BISTRO SKAAL x 2/4  
BISTRO TABLE SKAAL

- |   |  |   |                               |
|---|--|---|-------------------------------|
| TA04054/P1<br>Céramique marbre noir<br>Ceramic marble black | TA04054/P2<br>Céramique blanche tadelakt<br>Ceramic white tadelakt | TA04054/P3<br>Céramique béton ciré<br>Ceramic white polished concrete | 1pc/2boxes  0,149 m³<br>30 kg |
|---|--|---|-------------------------------|



TABLE PIED CENTRAL MANGE DEBOUT SKAAL x 2/4  
SKAAL CENTRAL FEET HIGH DINING TABLE

- |   |  |   |                                  |
|---|--|---|----------------------------------|
| TA04059/P1<br>Céramique marbre noir<br>Ceramic marble black | TA04059/P2<br>Céramique blanche tadelakt<br>Ceramic white tadelakt | TA04059/P3<br>Céramique béton ciré<br>Ceramic white polished concrete | 2pcs/3boxes  0,28 m³<br>34,23 kg |
|---|--|---|----------------------------------|



TABLE MANGE DEBOUT SKAAL x 2/4  
SKAAL HIGH DINING TABLE

- |   |  |   |                               |
|---|--|---|-------------------------------|
| TA04056/P1<br>Céramique marbre noir<br>Ceramic marble black | TA04056/P2<br>Céramique blanche tadelakt<br>Ceramic white tadelakt | TA04056/P3<br>Céramique béton ciré<br>Ceramic white polished concrete | 1pc/2boxes  0,311 m³<br>39 kg |
|---|--|---|-------------------------------|



TABLE BISTRO SKAAL x 4/6  
SKAAL BISTRO TABLE

- |   |  |   |                                  |
|---|--|---|----------------------------------|
| TA04055/P1<br>Céramique marbre noir<br>Ceramic marble black | TA04055/P2<br>Céramique blanche tadelakt<br>Ceramic white tadelakt | TA04055/P3<br>Céramique béton ciré<br>Ceramic white polished concrete | 1pc/3boxes  0,232 m³<br>45,50 kg |
|---|--|---|----------------------------------|



TABLE MANGE DEBOUT SKAAL x 4/6  
SKAAL HIGH DINING TABLE

- |   |  |   |                                  |
|---|--|---|----------------------------------|
| TA04057/P1<br>Céramique marbre noir<br>Ceramic marble black | TA04057/P2<br>Céramique blanche tadelakt<br>Ceramic white tadelakt | TA04057/P3<br>Céramique béton ciré<br>Ceramic white polished concrete | 1pc/3boxes  0,324 m³<br>46,50 kg |
|---|--|---|----------------------------------|



CANAPÉ x 3/4  
3 SEATS SOFA



Teck massif à la finition Duratek®, Sunbrella® Lopi marbre, Coussins déco x3  
Duratek® finish solid teak, Marble Sunbrella® Lopi, Deco cushions x3

1pc/3boxes 2,424 m³  
81,6 kg



Teck massif à la finition Duratek®, Sunbrella® natté gris clair, Coussins déco x3  
Duratek® finish solid teak, Natte light grey Sunbrella®, Deco cushions x3



Teck massif à la finition Duratek®, Sunbrella® Tundra, Coussins déco x3  
Duratek® finish solid teak, Sunbrella® Tundra, Deco cushions x3

HOUSSE DE PROTECTION  
PROTECTION COVER  
HP03530



TABLE BASSE CÉRAMIQUE (XXL) SKAAL  
SKAAL CERAMIC COFFEE TABLE (XXL)



Céramique marbre noir  
Ceramic marble black

1pc/4boxes 0,536 m³  
67,50 kg



Céramique blanche tadelakt  
Ceramic white tadelakt



Céramique béton ciré  
Ceramic white polish concrete



CANAPÉ x 2/3  
2 SEATS SOFA



Teck massif à la finition Duratek®, Sunbrella® Lopi marbre, Coussins déco x2  
Duratek® finish solid teak, Marble Sunbrella® Lopi, Deco cushions x2

1pc/2boxes 1,627 m³  
51,40 kg



Teck massif à la finition Duratek®, Sunbrella® natté gris clair, Coussins déco x2  
Duratek® finish solid teak, Natte light grey Sunbrella®, Deco cushions x2



Teck massif à la finition Duratek®, Sunbrella® Tundra, Coussins déco x2  
Duratek® finish solid teak, Sunbrella® Tundra, Deco cushions x2

HOUSSE DE PROTECTION  
PROTECTION COVER  
HP03531

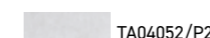

TABLE BASSE CÉRAMIQUE SKAAL  
SKAAL CERAMIC COFFEE TABLE



Céramique marbre noir  
Ceramic marble black

1pc/3boxes 0,297 m³  
38,50 kg



Céramique blanche tadelakt  
Ceramic white tadelakt

TA04052/P3  
Céramique béton ciré  
Ceramic white polish concrete



FAUTEUIL CLUB  
CLUB ARMCHAIR



Teck massif à la finition Duratek®, Sunbrella® Lopi marbre, Coussins déco x1  
Duratek® finish solid teak, Marble Sunbrella® Lopi, Deco cushions x1

1pc/2boxes 0,893 m³  
30,20 kg

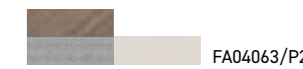

Teck massif à la finition Duratek®, Sunbrella® natté gris clair, Coussins déco x1  
Duratek® finish solid teak, Natte light grey Sunbrella®, Deco cushions x1



Teck massif à la finition Duratek®, Sunbrella® Tundra, Coussins déco x1  
Duratek® finish solid teak, Sunbrella® Tundra, Deco cushions x1

HOUSSE DE PROTECTION  
PROTECTION COVER  
HP03535



TABLE BASSE CÉRAMIQUE SKAAL  
SKAAL CERAMIC COFFEE TABLE



Céramique marbre noir  
Ceramic marble black

2pcs/2boxes 0,13 m³  
27,50 kg



Céramique blanche tadelakt  
Ceramic white tadelakt

TA04053/P3  
Céramique béton ciré  
Ceramic white polish concrete



CANAPÉ SKAAL (S) x 2  
SKAAL SOFA (SMALL SIZE)

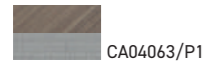

Teck massif à la finition Duratek®, Sunbrella® natté gris clair  
Duratek® finish solid teak, Natte light grey Sunbrella®  
1pc/2boxes 0,96 m³  
39 kg

HOUSSE DE PROTECTION  
PROTECTION COVER  
HP03532



FAUTEUIL SKAAL (S) x 2  
SKAAL LOW ARMCHAIR (SMALL SIZE)

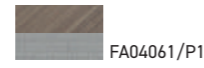

Teck massif à la finition Duratek®, Sunbrella® natté gris clair  
Duratek® finish solid teak, Natte light grey Sunbrella®L  
1pc/2boxes 0,556 m³  
21 kg

HOUSSE DE PROTECTION  
PROTECTION COVER  
HP03536



TABLE BASSE HPL (XL) SKAAL  
SKAAL HPL LOW TABLE (XL SIZE)



Teck massif à la finition Duratek®, HPL béton ciré  
Duratek® finish solid teak, white wash concrete HPL  
1pc/1box 0,762 m³  
46 kg



TABLE BASSE HPL (M) SKAAL  
SKAAL HPL LOW TABLE (MEDIUM SIZE)

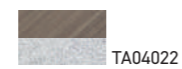

Teck massif à la finition Duratek®, HPL béton ciré  
Duratek® finish solid teak, white wash concrete HPL  
1pc/1box 0,397 m³  
25 kg



TABLE BASSE HPL (S) SKAAL  
SKAAL HPL LOW TABLE (SMALL SIZE)



Teck massif à la finition Duratek®, HPL béton ciré  
Duratek® finish solid teak, white wash concrete HPL  
1pc/1box 0,242 m³  
13 kg

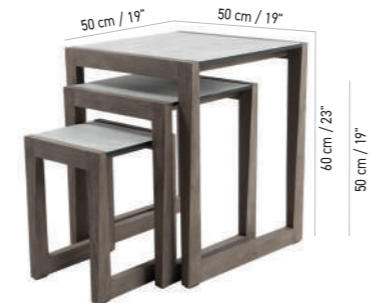

LOT DE 3 TABLES GIGOGNES HPL SKAAL  
SKAAL HPL SET OF 3 LOW TABLES



Teck massif à la finition Duratek®, HPL béton ciré  
Duratek® finish solid teak, white wash concrete HPL  
3pcs/1box 0,252 m³  
16 kg



COFFRE SKAAL  
SKAAL CUSHION BOX



Teck massif à la finition Duratek®  
Duratek® finish solid teak  
1pc/1box 1,175 m³  
57 kg



BUFFET 2 PORTES SKAAL  
SKAAL TWO DOORS STORAGE CABINET

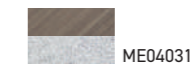

Teck massif à la finition Duratek®, HPL béton ciré  
Duratek® finish solid teak, white wash concrete HPL  
1pc/1box 0,718 m³  
59 kg



PARASOL SKAAL EXCENTRÉ 3 x 3 SOCLE EN GRANITE AVEC ROULETTES INOX + HOUSSE DE PROTECTION  
SKAAL HANGING UMBRELLA WITH GRANIT BASE, INOX WHEEL + PROTECTION COVER

**PES3030/P1**  
Aluminium effet Duratek®, Sunbrella® natté gris clair, socle granite  
Duratek® aluminum, Nette light grey Sunbrella®, granit plinth

1pc/3boxes 0,394 m³  
136 kg



BAIN DE SOLEIL SKAAL  
SKAAL SUNLOUNGER

**TR04041**  
Batyline Eden blanc chiné  
White grey Eden Batyline

1pc/1box 0,782 m³  
23 kg

KIT DE ROULETTES À FIXER POUR BAIN DE SOLEIL TR04041  
BACKWHEELS KIT FOR SUNLOUNGER TR04041  
KR04099

TABLE BASSE HPL SKAAL  
SKAAL HPL LOW TABLE

**TA04083**  
HPL béton ciré  
White wash concrete HPL

1pc/1box 0,07 m³  
3,5 kg

COUSSIN POUR BAIN DE SOLEIL  
CUSHION FOR SUNLOUNGER

**C006162**  
Ateja gris clair  
Light grey Ateja

1pc/1box 0,182 m³  
5 kg

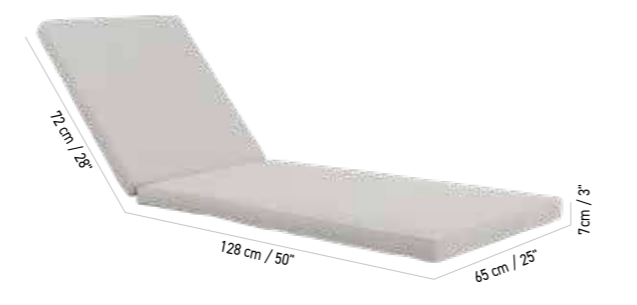

KIOSQUE SKAAL  
SKAAL SUNBED

**DBGW522**  
Teck massif à la finition Duratek®, Sunbrella® natté gris clair, Batyline Eden blanc chiné  
Duratek® finish solid teak, Nette light grey Sunbrella®, White grey Eden Batyline

1pc/3boxes 1,48 m³  
169 kg

# COPENHAGUE

Design by 2x5 design



L'incontournable design scandinave s'invite au jardin. Sobriété et élégance sont les maîtres-mots de cette collection aux accents nordiques.  
Copenhagen or the unmistakable Scandinavian touch...This collection displays an understated elegance.

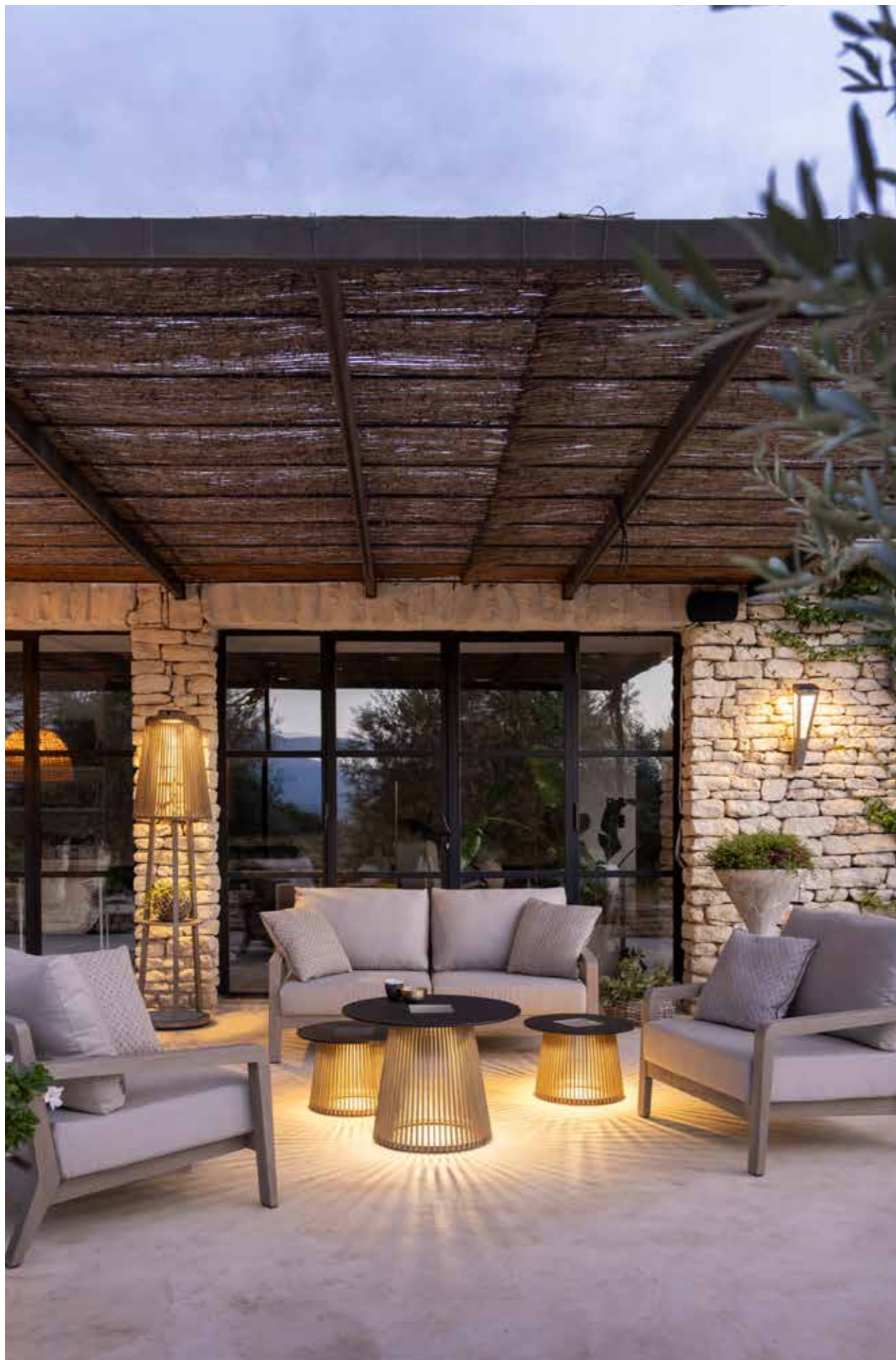

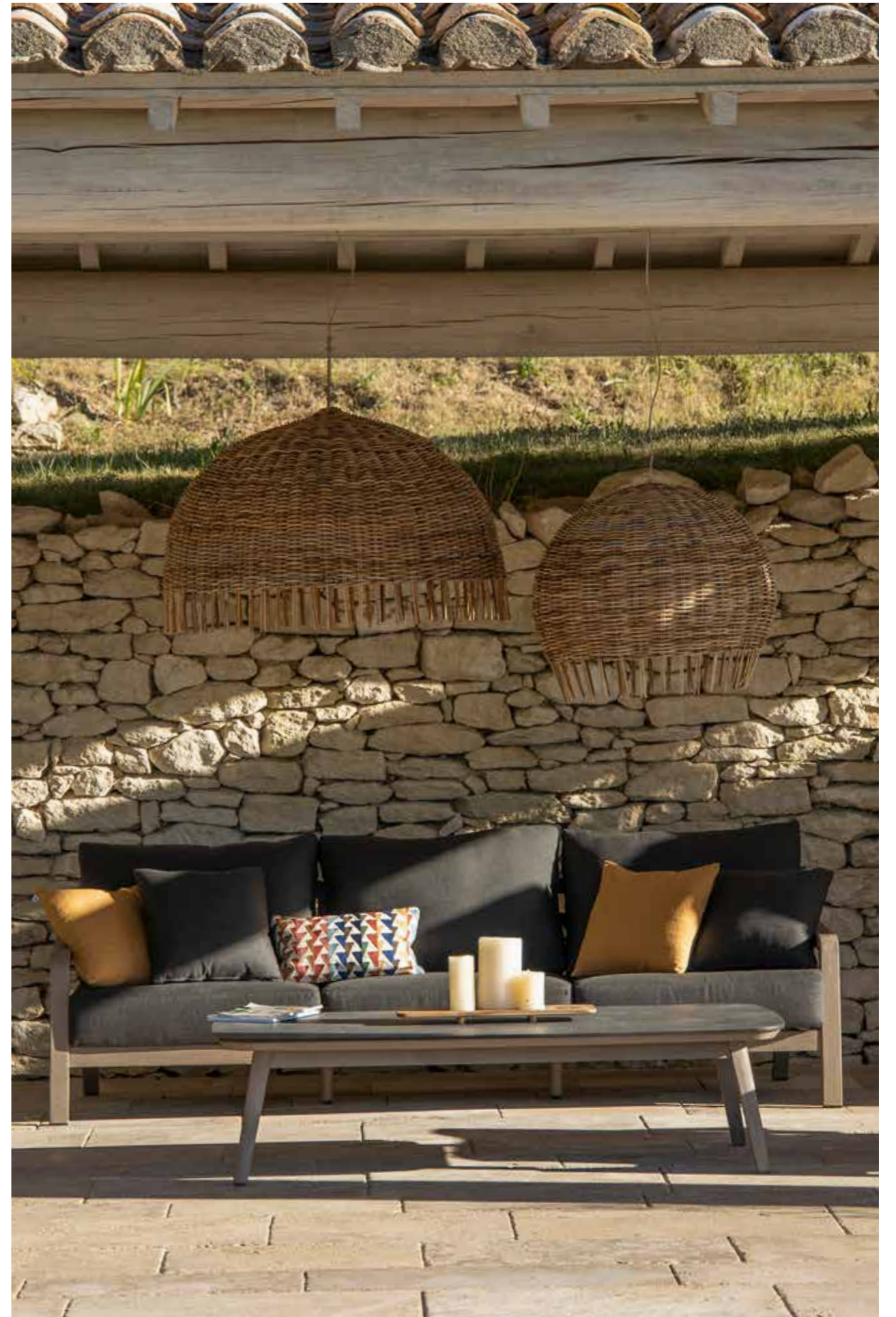



Matières : Teck massif à la finition Duratek®, coussinage Sunbrella®, toile grafito et Agora panama, HPL finition béton ciré, corde plate.

Entretien : Le Duratek® ne nécessite pas d'entretien et peut rester dehors toute l'année sans altération de sa couleur, il en va de même pour la toile Batyline. Les coussins sont déperlants mais doivent être hivernés. Nous conseillons de nettoyer le plateau des tables en HPL après chaque repas à l'eau savonneuse ou au nettoyant pour vitres. Ne pas utiliser de produits abrasifs pour l'entretien du Duratek®.

Materials: Solid teak Duratek® finish, Sunbrella® cushions and grafito and Agora panama, White wash concrete HPL, flat rope.

Maintenance: The Duratek® doesn't need maintenance, it can stay outside all year long, just like the Batyline sling chairs. Cushions are water repellent, but need to be stored in winter. It is advisable to clean up the table HPL tops after each meal. Do not use abrasive products to clean Duratek®/frames.



# COPENHAGUE

BAIN DE SOLEIL, TABLE BASSE

SUNLOUNGER, LOW TABLE



BAIN DE SOLEIL EMPILABLE COPENHAGUE AVEC ROUES ARRIÈRES  
COPENHAGUE STACKABLE SUNLOUNGER, BACKWHEELS

TABLE BASSE COPENHAGUE HPL POUR BAIN DE SOLEIL  
COPENHAGUE HPL LOW TABLE FOR SUNLOUNGER



TR04250  
Teck massif à la finition Duratek®  
Batyline Eden blanc chiné  
Duratek® finish solid teak,  
white grey Eden Batyline

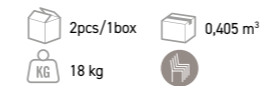

TR04251Y  
Teck massif à la finition Duratek®  
toile tissée grafito  
Duratek® finish solid teak,  
grafito woven canvas

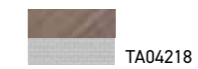

TA04218  
Teck massif à la finition Duratek®  
HPL béton ciré  
Duratek® finish solid teak,  
white wash concrete HPL

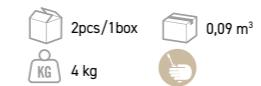

TA04217  
Teck massif à la finition Duratek®  
HPL ardoise  
Duratek® finish solid teak,  
slate grey HPL

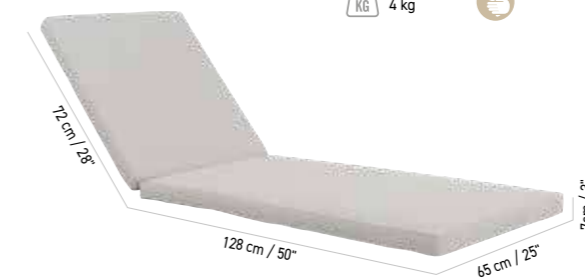

COUSSIN POUR BAIN DE SOLEIL  
ATEJA CUSHION FOR SUNLOUNGER

CO06162

Ateja gris clair  
Light grey Ateja



ADIRONDACK HPL COPENHAGUE  
COPENHAGUE HPL ADIRONDACK



FA22016  
Teck massif à la finition Duratek®  
HPL ardoise  
Duratek® finish solid teak,  
slate grey HPL

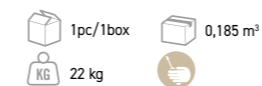

JEU DE COUSSINS SUNBRELLA® POUR  
ADIRONDACK (ASSISE ET APPUI TÊTE)  
CUSHION SET FOR ADIRONDACK IN SUNBRELLA®



CO42016  
Sunbrella® grafito  
Grafito Sunbrella

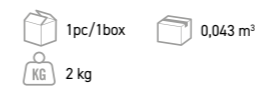

TABLE BASSE ADIRONDACK HPL (M)  
COPENHAGUE  
COPENHAGUE HPL ADIRONDACK  
LOW TABLE (MEDIUM SIZE)



TA32016  
Teck massif à la finition Duratek®  
HPL ardoise  
Duratek® finish solid teak,  
slate grey HPL

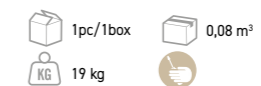
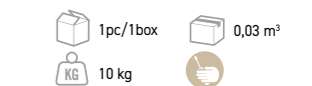

TABLE BASSE ADIRONDACK HPL (S)  
COPENHAGUE  
COPENHAGUE HPL ADIRONDACK  
LOW TABLE (SMALL SIZE)



TA52016  
Teck massif à la finition Duratek®  
HPL ardoise  
Duratek® finish solid teak,  
slate grey HPL



# COPENHAGUE

## CANAPÉ, FAUTEUIL, TABLE BASSE ET COUSSIN

SOFA, ARMCHAIR, LOW TABLE AND CUSHION



CANAPÉ COPENHAGUE x 3/4  
COPENHAGUE 3 SEATS SOFA

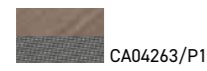

CA04263/P1  
Teck massif à la finition Duratek®,  
Sumbrella® natté grafito,  
Coussins déco grafito x3  
Duratek® finish solid teak,  
Natte grafito Sumbrella®,  
Deco cushions grafito



CA04263/P2  
Teck massif à la finition Duratek®,  
Agora Panama fossil,  
Coussins déco rafia x3  
Duratek® finish solid teak,  
Agora Panama fossil,  
Deco cushions rafia

2pcs/3boxes 2,5 m³  
88 kg  
HOUSSE DE PROTECTION  
PROTECTION COVER  
HP03530



CANAPÉ COPENHAGUE x 2/3  
COPENHAGUE 2 SEATS SOFA

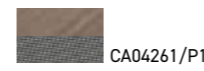

CA04261/P1  
Teck massif à la finition Duratek®,  
Sumbrella® natté grafito,  
Coussins déco grafito x2  
Duratek® finish solid teak,  
Natte grafito Sumbrella®,  
Deco cushions grafito

2pcs/2boxes 1,89 m³  
55 kg



CA04261/P2  
Teck massif à la finition Duratek®,  
Agora Panama fossil,  
Coussins déco rafia x2  
Duratek® finish solid teak,  
Agora Panama fossil,  
Deco cushions rafia



FAUTEUIL COPENHAGUE  
COPENHAGUE ARMCHAIR

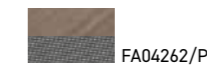

FA04262/P1  
Teck massif à la finition Duratek®,  
Sumbrella® natté grafito,  
Coussins déco grafito x1  
Duratek® finish solid teak,  
Natte grafito Sumbrella®,  
Deco cushions grafito

2pcs/2boxes 0,975 m³  
30 kg



FA04262/P2  
Teck massif à la finition Duratek®,  
Agora Panama fossil,  
Coussins déco rafia x1  
Duratek® finish solid teak,  
Agora Panama fossil,  
Deco cushions rafia

✚ Duratek\*\* : notre teck massif sans entretien / our maintenance-free solid teak

HOUSSE DE PROTECTION  
PROTECTION COVER  
HP03531

HOUSSE DE PROTECTION  
PROTECTION COVER  
HP03535



TABLE BASSE LUMINEUSE SOLAIRE ET RECHARGEABLE TECKA  
TECKA LOW TABLE SOLAR AND RECHARGEABLE LIGHTING



TA04503  
Teck massif à la finition Duratek®,  
HPL ardoise, plaque en verre dépoli acrylique  
Duratek® finish solid teak, slate grey HPL,  
acrylic plate frosted glass

1pc/3boxes 0,214 m³  
9 kg



TABLE BASSE LUMINEUSE SOLAIRE ET RECHARGEABLE TECKA  
TECKA LOW TABLE SOLAR AND RECHARGEABLE LIGHTING



TA04500A  
Teck massif à la finition Duratek®,  
HPL ardoise, plaque en verre dépoli acrylique  
Duratek® finish solid teak, slate grey HPL,  
acrylic plate frosted glass

1pc/2boxes 0,127 m³  
5,5 kg



TABLE BASSE HPL (XL) COPENHAGUE  
COPENHAGUE HPL LOW TABLE (XL SIZE)



TA04215  
Teck massif à la finition Duratek®,  
HPL ardoise  
Duratek® finish solid teak,  
slate HPL

1pc/1box 0,18 m³  
33 kg



TA04211  
Teck massif à la finition Duratek®,  
HPL béton ciré  
Duratek® finish solid teak,  
white wash concrete HPL



TABLE BASSE HPL (M) COPENHAGUE  
COPENHAGUE HPL LOW TABLE (MEDIUM SIZE)



TA04216  
Teck massif à la finition Duratek®,  
HPL ardoise  
Duratek® finish solid teak,  
slate HPL

1pc/1box 0,09 m³  
16,5 kg



TA04212  
Teck massif à la finition Duratek®,  
HPL béton ciré  
Duratek® finish solid teak,  
white wash concrete HPL



# COPENHAGUE

ENSEMBLE BAS

LOW



CANAPÉ BAS, EMPILABLE, TRESSÉ, 2 PLACES COPENHAGUE  
COPENHAGUE 2 SEATS SOFA



CA04267

Teck massif à la finition Duratek®,  
corde plate grafito  
Duratek® finish solid teak,  
flat rope grafito



2pcs/1box



0,51 m³



17,85 kg



CA04268

Teck massif à la finition Duratek®,  
corde plate beige chiné  
Duratek® finish solid teak,  
flat rope beige white



FAUTEUIL BAS, EMPILABLE, TRESSÉ COPENHAGUE  
COPENHAGUE ARMCHAIR



FA04268

Teck massif à la finition Duratek®,  
corde plate grafito  
Duratek® finish solid teak,  
flat rope grafito



2pcs/1box



0,29 m³



8,7 kg



FA04267

Teck massif à la finition Duratek®,  
corde plate beige chiné  
Duratek® finish solid teak,  
flat rope beige white



CANAPÉ BAS EMPILABLE COPENHAGUE x 2  
COPENHAGUE STACKING 2 SEAT SOFA



CA04265Y

Teck massif à la finition Duratek®,  
toile tissée grafito  
Duratek® finish solid teak,  
grafito woven canvas



2pcs/1box



0,51 m³



13 kg



CA04266

Teck massif à la finition Duratek®,  
Batyline Eden blanc chiné  
Duratek® finish solid teak,  
white grey Eden Batyline



FAUTEUIL BAS EMPILABLE COPENHAGUE  
COPENHAGUE STACKING LOW ARMCHAIR



FA04265Y

Teck massif à la finition Duratek®,  
toile tissée grafito  
Duratek® finish solid teak,  
grafito woven canvas



2pcs/1box



0,29 m³



8,5 kg



FA04266

Teck massif à la finition Duratek®,  
Batyline Eden blanc chiné  
Duratek® finish solid teak,  
white grey Eden Batyline

# COPENHAGUE

LES MODULABLES  
MODULARS

1 / Choisissez un plateau - Choose a tray 2 / Choisissez les pieds - Choose the feet

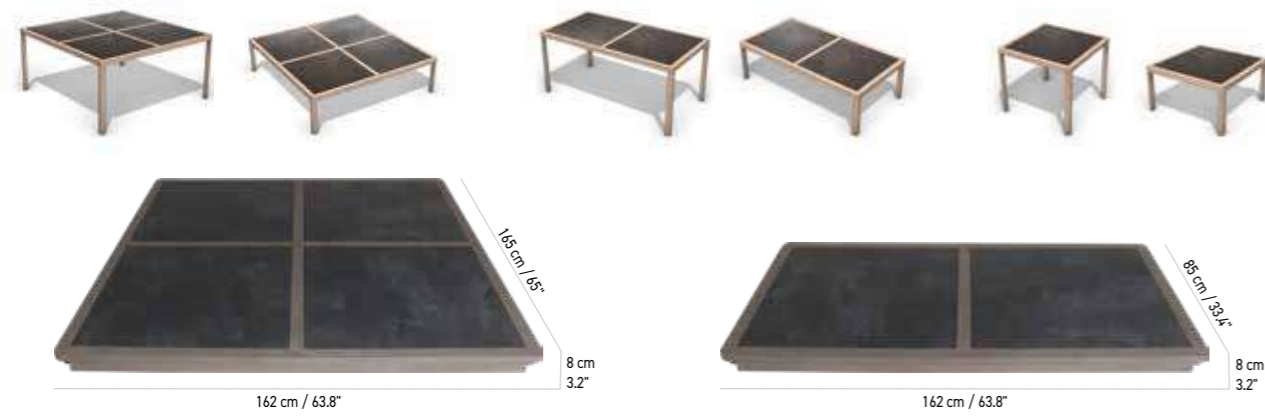

PLATEAU HPL (XXL) COPENHAGUE x 8  
COPENHAGUE HPL TABLE (XXL)

**PL04230**  
Teck massif à la finition Duratek®  
HPL ardoise  
Duratek® finish solid teak,  
slate HPL

1pc/1box  
40 kg  
0,34 m³

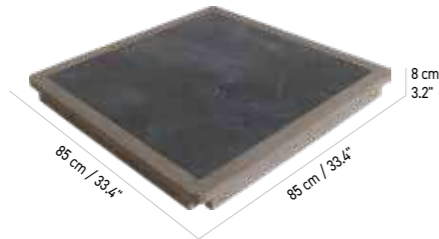

PLATEAU HPL COPENHAGUE x 4  
COPENHAGUE HPL TOP TABLE

**PL04232**  
Teck massif à la finition Duratek®  
HPL ardoise  
Duratek® finish solid teak,  
slate HPL

1pc/1box  
14 kg  
0,08 m³



PLATEAU HPL COPENHAGUE x 6  
COPENHAGUE HPL TOP TABLE

**PL04231**  
Teck massif à la finition Duratek®  
HPL ardoise  
Duratek® finish solid teak,  
slate HPL

1pc/1box  
24 kg  
0,18 m³

JEU DE 4 PIEDS POUR TABLE BASSE  
SET OF 4 FEET FOR LOW TABLE

**PT04230**  
Teck massif à la finition Duratek®  
Duratek® finish solid teak,

4pcs/1box  
4 kg  
0,01 m³

5 cm / 2"  
5 cm / 2"  
42 cm / 16.3"

JEU DE 4 PIEDS POUR TABLE  
SET OF 4 FEET FOR TABLE

**PT04231**  
Teck massif à la finition Duratek®  
Duratek® finish solid teak,

4pcs/1box  
6 kg  
0,017 m³

5 cm / 2"  
5 cm / 2"  
71,5 cm / 28.2"

TABLE HAUTE HPL COPENHAGUE x 4  
COPENHAGUE HPL HIGH DINING TABLE

**PL04232/P1**  
Teck massif à la finition Duratek®  
HPL ardoise  
Duratek® finish solid teak,  
slate HPL

1pc/2boxes  
22 kg  
0,211 m³



FAUTEUIL EMPILABLE, TRESSÉ,  
COPENHAGUE  
COPENHAGUE STACKABLE  
ROPE ARMCHAIR

**FA04251**  
Teck massif à la finition Duratek®,  
corde plate grafito  
Duratek® finish solid teak,  
flat rope grafito

**FA04250**  
Teck massif à la finition Duratek®,  
corde plate beige chiné  
Duratek® finish solid teak,  
flat rope beige white

2pcs/1box  
7,75 kg  
0,26 m³



CHAISE EMPILABLE, TRESSÉE,  
COPENHAGUE  
COPENHAGUE STACKABLE  
ROPE CHAIR

**CH04251**  
Teck massif à la finition Duratek®,  
corde plate grafito  
Duratek® finish solid teak,  
flat rope grafito

**CH04250**  
Teck massif à la finition Duratek®,  
corde plate beige chiné  
Duratek® finish solid teak,  
flat rope beige white

2pcs/1box  
6,25 kg  
0,215 m³



FAUTEUIL EMPILABLE  
COPENHAGUE  
COPENHAGUE STACKABLE  
ARMCCHAIR

**FA04241Y**  
Teck massif à la finition Duratek®,  
toile tissée grafito  
Duratek® finish solid teak,  
grafito woven canvas

**FA04231**  
Teck massif à la finition Duratek®,  
Batyline Eden blanc chiné  
Duratek® finish solid teak,  
white grey Eden Batyline

2pcs/1box  
6 kg  
0,26 m³



CHAISE EMPILABLE  
COPENHAGUE  
COPENHAGUE STACKABLE  
CHAIR

**CH04240Y**  
Teck massif à la finition Duratek®,  
toile tissée grafito  
Duratek® finish solid teak,  
grafito woven canvas

**CH04230**  
Teck massif à la finition Duratek®,  
Batyline Eden blanc chiné  
Duratek® finish solid teak,  
white grey Eden Batyline

2pcs/1box  
5 kg  
0,215 m³

TABOURET COPENHAGUE  
STOOL COPENHAGUE

**TAB4267**  
Teck massif à la finition Duratek®,  
toile tissée grafito  
Duratek® finish solid teak,  
grafito woven canvas

**TAB4268**  
Teck massif à la finition Duratek®,  
Batyline Eden blanc chiné  
Duratek® finish solid teak,  
white grey Eden Batyline

2pcs/1box  
7,25 kg  
0,389 m³



TABOURET COPENHAGUE  
STOOL COPENHAGUE

**TAB4265Y**  
Teck massif à la finition Duratek®,  
toile tissée grafito  
Duratek® finish solid teak,  
grafito woven canvas

**TAB4266**  
Teck massif à la finition Duratek®,  
Batyline Eden blanc chiné  
Duratek® finish solid teak,  
white grey Eden Batyline

2pcs/1box  
9 kg  
0,261 m³



# COPENHAGUE

TABLE EXTENSIBLE, TABLE BISTRO

SUNLOUNGER, LOW TABLE



TABLE EXTENSIBLE ALUMINIUM ET HPL **x 10/12**  
AVEC ALLONGE PAR SYSTEME DE LEVIER COPENHAGUE  
COPENHAGUE ALUMINIUM AND HPL EXTENDING TABLE WITH LEVER SYSTEM

- TA04207**  
Aluminium gris espace, HPL ardoise  
Space grey aluminum, slate grey HPL
- TA04209**  
Aluminium gris espace, HPL béton ciré  
Space grey aluminum, white wash concrete HPL

1pc/1box 0,554 m<sup>3</sup>  
72 kg



TABLE EXTENSIBLE DURATEK® ET CÉRAMIQUE **x 8/10**  
PAR SYSTEME DE LEVIER COPENHAGUE  
COPENHAGUE CERAMIC EXTENDING DURATEK® TABLE WITH LEVER SYSTEM

- TA04206**  
Teck massif à la finition Duratek®, céramique Lavica beige  
Duratek® finish solid teak, Lavica beige ceramic

1pc/2boxes 0,565 m<sup>3</sup>  
95 kg

TABLE EXTENSIBLE DURATEK® ET HPL **x 8/10**  
AVEC ALLONGE PAPILLON COPENHAGUE  
COPENHAGUE HPL EXTENDING DURATEK® TABLE WITH BUTTERFLY EXTENSION

- TA04208**  
Teck massif à la finition Duratek®  
HPL béton ciré  
Duratek® finish solid teak, white wash concrete HPL



+ Duratek® : notre teck massif sans entretien / our maintenance-free solid teak

TABLE BISTRO DURATEK® ET HPL **x 4**  
COPENHAGUE  
COPENHAGUE HPL DURATEK® TABLE

- TA04202\***  
Teck massif à la finition Duratek®  
HPL ardoise  
Duratek® finish solid teak, slate grey HPL

1pc/2boxes 0,45 m<sup>3</sup>  
56,7 kg



TABLE BISTRO DURATEK® ET HPL **x 2**  
COPENHAGUE  
COPENHAGUE HPL DURATEK® TABLE

- TA04201**  
Teck massif à la finition Duratek®  
HPL ardoise  
Duratek® finish solid teak, slate grey HPL

1pc/2boxes 0,246 m<sup>3</sup>  
40 kg



TABLE RONDE CÉRAMIQUE **x 3/4**  
COPENHAGUE  
COPENHAGUE CERAMIC  
ROUND TABLE

- TA04220\***  
Teck massif à la finition Duratek®  
céramique ciment blanc, granite  
Duratek® finish solid teak, cement white ceramic, granit

1pc/3boxes 0,277 m<sup>3</sup>  
47,9 kg



MANGE DEBOUT CÉRAMIQUE  
COPENHAGUE  
COPENHAGUE CERAMIC  
ROUND TABLE

- TA04280\***  
Teck massif à la finition Duratek®  
céramique ciment blanc, granite  
Duratek® finish solid teak, cement white ceramic, granit

1pc/2boxes 0,277 m<sup>3</sup>  
47,9 kg

\* Ce produit existe dans d'autres formats, il est disponible sur commande. This product exists in other formats and is available to order.

\* Ce produit existe dans d'autres formats, il est disponible sur commande. This product exists in other formats and is available to order.

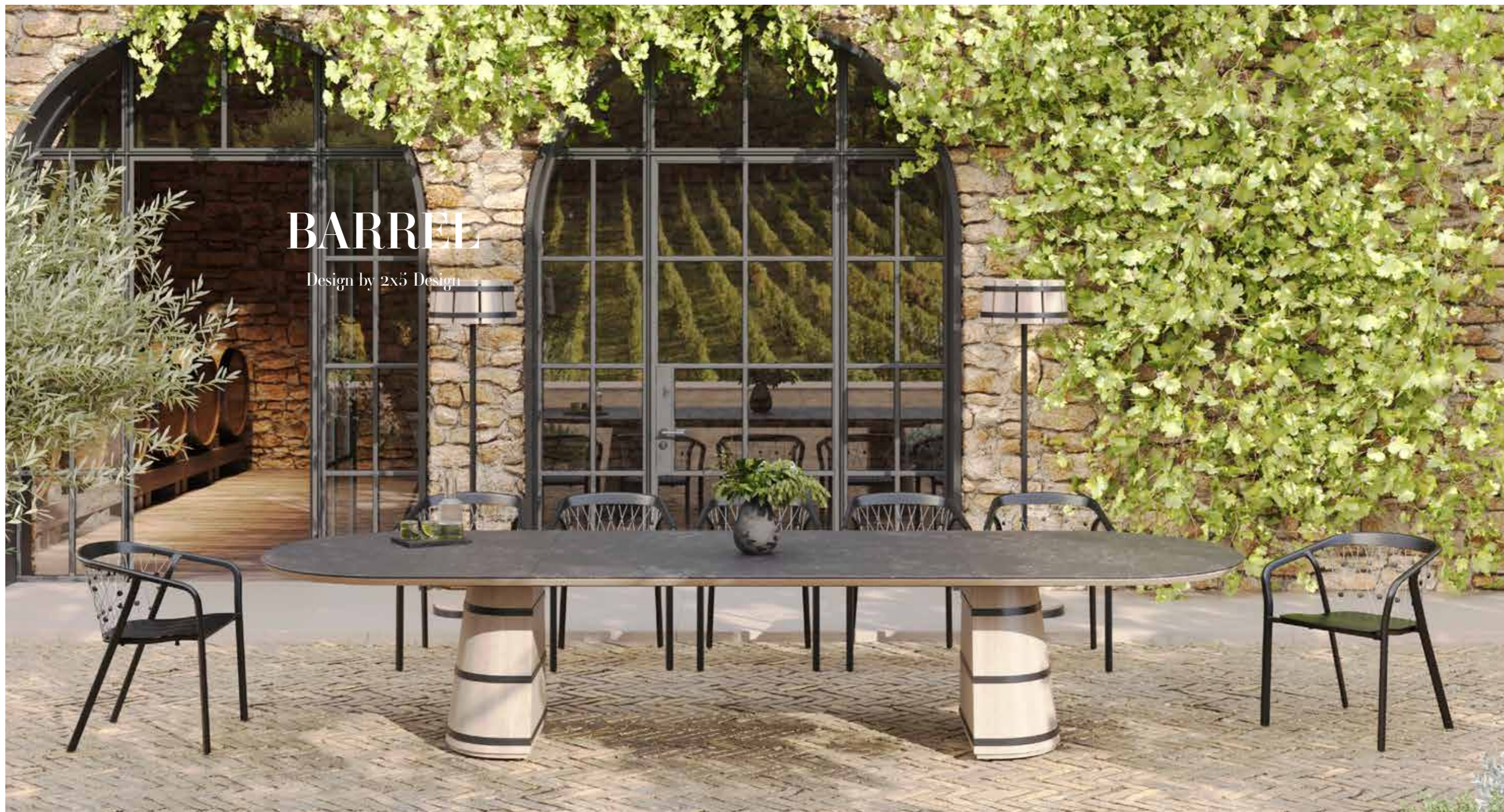

# BARREL

Design by 2x5 Design

La collection Barrel incarne une singularité audacieuse. Puisant son essence dans l'univers authentique des vignobles, elle confère aux espaces extérieurs une chaleur enveloppante et un caractère affirmé. Réalisée en teck massif avec une finition Duratek®, ses lames évoquent avec élégance l'esthétique des tonneaux, se mariant harmonieusement au cerclage noir et aux étoffes texturées. Ce mariage subtil de matériaux témoigne d'un savoir-faire artisanal, offrant un contraste chaleureux et élégant pour un confort optimal.

The Barrel collection embodies a bold singularity. Drawing its essence from the authentic world of vineyards, it lends outdoor spaces an enveloping warmth and assertive character. Made from solid teak with a Duratek® finish, its slats elegantly evoke the aesthetics of barrels, blending harmoniously with black strapping and textured fabrics. This subtle marriage of materials is a testament to craftsmanship, offering a warm, elegant contrast for optimum comfort.





# BARREL

TABLE DE REPAS  
DINNING TABLE



TABLE DE REPAS OVALE BARREL x 12/14  
BARREL OVAL DINING TABLE



Teck massif à la finition Duratek®,  
Céramique belgium anthracite,  
aluminium noir  
Duratek® finish solid teak,  
Belgium dark grey ceramic,  
black aluminum



Teck massif à la finition Duratek®,  
Céramique pierre naturelle,  
aluminium noir  
Duratek® finish solid teak,  
Silk stone white ceramic,  
black aluminum

1pc/3boxes 1,074 m<sup>3</sup>  
130,70 kg



120 cm / 47.24"



340 cm / 134"

# BARREL

CANAPÉ, FAUTEUIL, TABLE BASSE  
SOFA, ARMCHAIR, LOW TABLE



CANAPÉ 2 PLACES BARREL x 2/3  
BARREL 2 SEATS SOFA



CA01500

Teck massif à la finition Duratek®,  
Ateja Bay gris chiné,  
Ateja La concha terracotta,  
aluminium noir  
Duratek® finish solid teak,  
Mottled grey Bay Ateja,  
Ateja La concha terracotta,  
black aluminum

1pc/1box 1,518 m³  
KG 40,30 kg



FAUTEUIL CLUB BARREL  
BARREL CLUB ARMCHAIR



FA01500

Teck massif à la finition Duratek®,  
Ateja Bay gris chiné,  
Ateja La concha terracotta,  
aluminium noir  
Duratek® finish solid teak,  
Mottled grey Bay Ateja,  
Ateja La concha terracotta,  
black aluminum

1pc/1box 0,847 m³  
KG 24,95 kg



TABLE BASSE BARREL  
BARREL LOW TABLE



TA01501

Teck massif à la finition Duratek®,  
Céramique belgium anthracite,  
aluminium noir  
Duratek® finish solid teak,  
Belgium dark grey ceramic,  
black aluminum

1pc/1box 0,147 m³  
KG 14,80 kg

+ Duratek® : notre teck massif sans entretien / our maintenance-free solid teak

+ Duratek® : notre teck massif sans entretien / our maintenance-free solid teak



FAUTEUIL DE REPAS BARREL  
BARREL DINING ARMCHAIR



CH01500

Teck massif à la finition Duratek®,  
Ateja Bay gris chiné,  
aluminium noir  
Duratek® finish solid teak,  
Mottled grey Bay Ateja,  
black aluminum

1pc/1box 0,485 m³  
KG 13 kg



TABLE BISTRO BARREL  
BARREL BISTRO TABLE



TA01563

Teck massif à la finition Duratek®,  
Céramique belgium anthracite,  
aluminium noir, base granite  
Duratek® finish solid teak,  
Belgium dark grey ceramic,  
black aluminum, granit base

1pc/3boxes 0,520 m³  
KG 51,15 kg



TABOURET BARREL  
BARREL STOOL



TAB1500

Teck massif à la finition Duratek®,  
Ateja Bay gris chiné,  
aluminium noir  
Duratek® finish solid teak,  
Mottled grey Bay Ateja,  
black aluminum

1pc/1box 0,336 m³  
KG 8,95 kg



MANGE-DEBOUT BARREL  
BARREL TABLE HIGH DINING



TA01562

Teck massif à la finition Duratek®,  
Céramique belgium anthracite,  
aluminium noir, base granite  
Duratek® finish solid teak,  
Belgium dark grey ceramic,  
black aluminum, granit base

1pc/3boxes 0,510 m³  
KG 44,40 kg



# MIRA

Design by 2x5 design

Collection capsule. Intemporelle et élégante, la collection MIRA se pare de teck massif à la finition Duratek® et de dossier en corde entièrement tressé à la main. Sa structure large est associée à des assises profondes et mœlleuses pour un plus grand confort.

Capsule collection. Timeless and elegant, the MIRA collection is adorned with Duratek® finished solid teak and hand-woven rope backrests. Its wide structure is combined with deep seat and soft cushions for greater comfort.





CANAPÉ 3 PLACES MIRA x 3  
MIRA 3 SEATERS SOFA BRAIDED ROPE



Teck massif à la finition Duratek®, Sunbrella® natté gris clair, Corde ronde grise Duratek® finish solid teak, Natte light grey Sunbrella®, Grey round rope



HOUSSE DE PROTECTION PROTECTION COVER HP03530

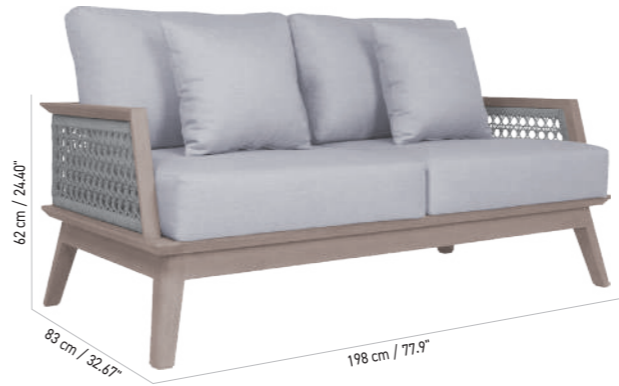

CANAPÉ 2 PLACES MIRA x 2  
MIRA 2 SEATERS SOFA BRAIDED ROPE



Teck massif à la finition Duratek®, Sunbrella® natté gris clair, Corde ronde grise Duratek® finish solid teak, Natte light grey Sunbrella®, Grey round rope

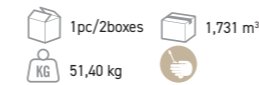

HOUSSE DE PROTECTION PROTECTION COVER HP03531

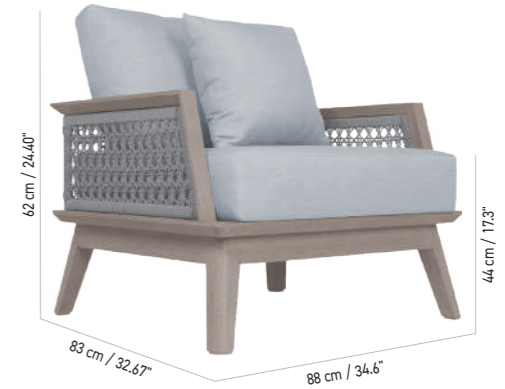

FAUTEUIL CLUB MIRA  
MIRA ARMCHAIR BRAIDED ROPE



Teck massif à la finition Duratek®, Sunbrella® natté gris clair, Corde ronde grise Duratek® finish solid teak, Natte light grey Sunbrella®, Grey round rope

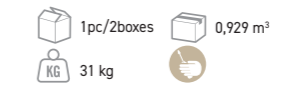

HOUSSE DE PROTECTION PROTECTION COVER HP03535



Matières : Teck massif à la finition Duratek®, coussinage Sunbrella®, corde, HPL finition béton ciré.

Entretien : Le Duratek® ne nécessite pas d'entretien et peut rester dehors toute l'année sans altération de sa couleur. Les coussins sont déperlants mais doivent être hivernés. Nous conseillons de nettoyer le plateau des tables en HPL après chaque repas à l'eau savonneuse ou au nettoyant pour vitres. Ne pas utiliser de produits abrasifs pour l'entretien du Duratek®.

Materials: Solid teak Duratek® finish, Sunbrella® cushions, rope, White wash concrete HPL.

Maintenance: The Duratek® doesn't need maintenance, it can stay outside all year long, just like the Batyline sling chairs. Cushions are water repellent, but need to be stored in winter. It is advisable to clean up the table HPL tops after each meal. Do not use abrasive products to clean Duratek®/frames.



TABLE BASSE HPL COPENHAGUE  
COPENHAGUE HPL LOW TABLE



Teck massif à la finition Duratek®, HPL béton ciré Duratek® finish solid teak, white wash concrete HPL





# SELVA

Design by Denali

Une collection de mobilier qui met l'accent sur la douceur et le confort. Les formes enveloppantes invitent à la détente en extérieur. Nouvelle technique chez LES JARDINS® : la structure des assises est totalement habillée de toile ATEJA micro perforée, qui lui confère un côté cocooning et chaleureux.

A collection based on softness and comfort. The curved shapes welcome you to relax. Thanks to a new production technic, the structure of the chair is totally covered by a very smooth and warm ATEJA sling.





Matières : Teck massif à la finition Duratek® sans entretien, coussinage et toile Ateja, HPL finition béton ciré.

Entretien : Le Duratek® ne nécessite pas d'entretien et peut rester dehors toute l'année sans altération de sa couleur, il en va de même pour la toile Ateja. Les coussins sont déperlants mais doivent être hivernés. Nous conseillons de nettoyer le plateau des tables en HPL après chaque repas à l'eau savonneuse ou au nettoyant pour vitres. Ne pas utiliser de produits abrasifs pour l'entretien du Duratek®.

Materials: Solid teak Duratek® finish with no maintenance, Ateja sling and cushions, White wash concrete HPL.

Maintenance: The Duratek® doesn't need maintenance, it can stay outside all year long, just like the Ateja sling chairs. Cushions are water repellent, but need to be stored in winter. It is advisable to clean up the table HPL tops after each meal. Do not use abrasive products to clean Duratek®/frames.

# SELVA

## CANAPÉ, FAUTEUIL ET TABLE BASSE

SOFA, ARMCHAIR AND LOW TABLE



**CANAPÉ 2 PLACES x2**  
**DOUBLE TOILE TENDUE SELVA**  
 2 SEATS SOFA SELVA STRETCHED DOUBLE CANVAS

CA08000

Teck massif à la finition Duratek®  
 toile Ateja blanc chiné, tissu Ateja gris clair  
 Duratek® finish solid teak, white grey  
 Ateja canvas, light grey Ateja sling

1pc/1box 1,217 m³

KG 24 kg

**FAUTEUIL BAS DOUBLE TOILE TENDUE SELVA**  
 LOW ARMCHAIR DOUBLE STRETCHED CANVAS SELVA

FA08100

Teck massif à la finition Duratek®  
 toile Ateja blanc chiné, tissu Ateja gris clair  
 Duratek® finish solid teak, white grey  
 Ateja canvas, light grey Ateja sling

1pc/1box 0,71 m³

KG 11 kg

+ Duratek® : notre teck massif sans entretien / our maintenance-free solid teak



**TABLE BASSE HPL SELVA**  
 SELVA HPL LOW TABLE

TA08101

Teck massif à la finition Duratek®  
 plateau plein HPL béton ciré  
 Duratek® finish solid teak,  
 white wash concrete HPL top

1pc/1box 0,024 m³

KG 5 kg



**TABLE BASSE HPL SELVA**  
 SELVA HPL LOW TABLE

TA08100

Teck massif à la finition Duratek®  
 plateau plein HPL béton ciré  
 Duratek® finish solid teak,  
 white wash concrete HPL top

1pc/1box 0,07 m³

KG 12 kg



# SELVA

TABLE ET ASSISE  
TABLE AND ARMCHAIR



TABLE FIXE SELVA x 6/8  
SELVA HPL FIX TABLE



Teck massif à la finition Duratek®  
plateau plein HPL béton ciré  
Duratek® finish solid teak,  
white wash concrete HPL top

1pc/1box 0,444 m³  
59,5 kg



FAUTEUIL EMPILABLE, TRESSÉ,  
COPENHAGUE  
COPENHAGUE STACKABLE  
ROPE ARMCHAIR



Teck massif à la finition Duratek®,  
corde plate grafito  
Duratek® finish solid teak,  
flat rope grafito



Teck massif à la finition Duratek®,  
corde plate beige chiné  
Duratek® finish solid teak,  
flat rope beige white

2pcs/1box 0,26 m³  
7,75 kg



CHAISE EMPILABLE, TRESSÉE,  
COPENHAGUE  
COPENHAGUE STACKABLE  
ROPE CHAIR

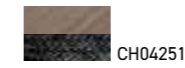

Teck massif à la finition Duratek®,  
corde plate grafito  
Duratek® finish solid teak,  
flat rope grafito

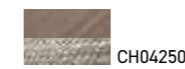

Teck massif à la finition Duratek®,  
corde plate beige chiné  
Duratek® finish solid teak,  
flat rope beige white

2pcs/1box 0,215 m³  
6,25 kg



FAUTEUIL EMPILABLE  
COPENHAGUE  
COPENHAGUE STACKABLE  
ARMCHAIR



Teck massif à la finition Duratek®,  
toile tissée grafito  
Duratek® finish solid teak,  
grfito woven canvas



Teck massif à la finition Duratek®,  
Batyline Eden blanc chiné  
Duratek® finish solid teak,  
white grey Eden Batyline

2pcs/1box 0,26 m³  
6 kg



CHAISE EMPILABLE  
COPENHAGUE  
COPENHAGUE STACKABLE  
CHAIR



Teck massif à la finition Duratek®,  
toile tissée grafito  
Duratek® finish solid teak,  
grfito woven canvas



Teck massif à la finition Duratek®,  
Batyline Eden blanc chiné  
Duratek® finish solid teak,  
white grey Eden Batyline

2pcs/1box 0,215 m³  
5 kg

# JET STREAM

Une ligne complète de modules en aluminium et en toile Batyline pour composer votre salon de jardin selon vos envies du fauteuil simple au canapé d'angle en passant par la méridienne.  
A complete line of modules in aluminum and Batyline fabric to create your own garden furniture, from simple armchairs to corner sofas and meridiennes.







Matières : Aluminium, toile Batyline, HPL / Entretien : Pas d'entretien particulier  
Materials: Aluminum, Batyline sling, HPL / Maintenance: No maintenance

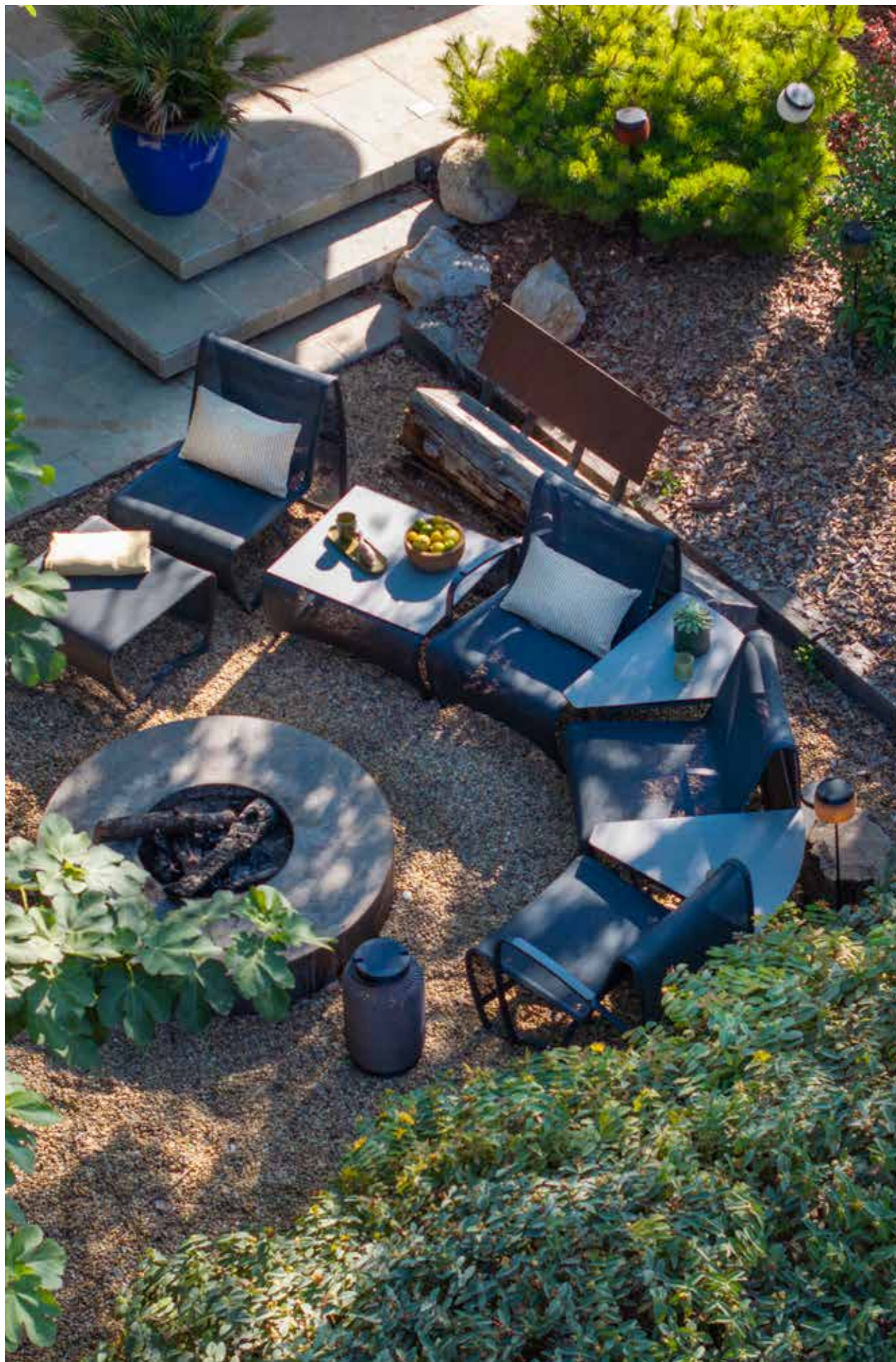

# JET STREAM LES MODULABLES

MODULARS



**MODULE JET STREAM**  
JET STREAM CENTRAL SOFA



Aluminium gris espace, Batyline ardoise  
Space grey aluminum, slate grey Batyline

2pcs/1box 0,265 m<sup>3</sup>  
5 kg

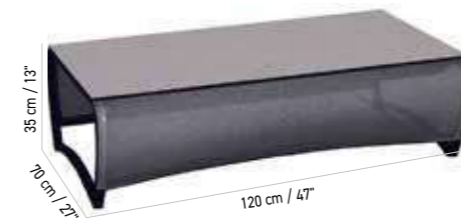

**TABLE BASSE HPL JET STREAM**  
JET STREAM HPL LOW TABLE



Aluminium gris espace, Batyline ardoise,  
plateau plein HPL céramique grise  
Space grey aluminum, slate grey Batyline,  
full grey ceramic HPL top

1pc/1box 0,366 m<sup>3</sup>  
15 kg



**TABLE BASSE HPL JET STREAM**  
JET STREAM HPL LOW TABLE



Aluminium gris espace, Batyline ardoise,  
plateau plein HPL céramique grise  
Space grey aluminum, slate grey Batyline,  
full grey ceramic HPL top

1pc/1box 0,219 m<sup>3</sup>  
10 kg



**JEU D'ACCOUDOIRS JET STREAM**  
ARMREST KIT JET STREAM



Aluminium gris espace, Batyline ardoise  
Space grey aluminum, slate grey Batyline

2pcs/1box 0,035 m<sup>3</sup>  
2 kg

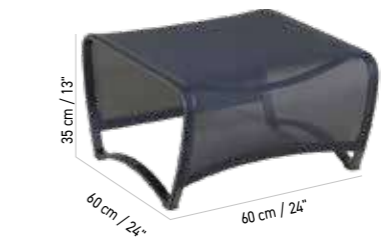

**REPOSE PIEDS JET STREAM**  
JET STREAM LEGREST

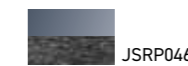

Aluminium gris espace, Batyline ardoise  
Space grey aluminum, slate grey Batyline

1pc/1box 0,165 m<sup>3</sup>  
4 kg



**TABLETTE DROITE JET STREAM**  
JET STREAM STRAIGHT SHELF



Aluminium gris espace,  
HPL céramique grise  
Space grey aluminum, grey ceramic HPL

1pc/1box 0,03 m<sup>3</sup>  
4 kg



**TABLETTE D'ANGLE JET STREAM**  
JET STREAM CORNER SHELF



Aluminium gris espace,  
HPL céramique grise  
Space grey aluminum, grey ceramic HPL

1pc/1box 0,049 m<sup>3</sup>  
5 kg

# JET STREAM LES MODULABLES

MODULARS



MODULE JET STREAM  
JET STREAM CENTRAL SOFA

**JSES020**  
Aluminium couleur Corten, toile tissée moka chiné  
Corten color aluminum, mocha mottled sling  
2pcs/1box 0,265 m<sup>3</sup>  
5 kg

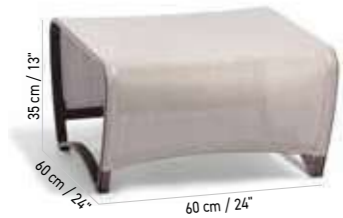

REPOSE PIEDS JET STREAM  
JET STREAM LEGREST

**JSRP050**  
Aluminium couleur Corten, toile tissée moka chiné  
Corten color aluminum, mocha mottled sling  
1pc/1box 0,165 m<sup>3</sup>  
4 kg

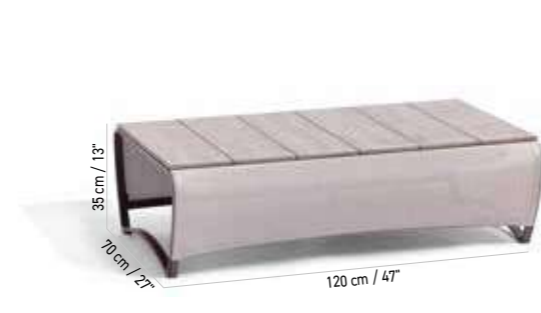

TABLE BASSE DURATEK® JET STREAM  
JET STREAM DURATEK® LOW TABLE

**JSTA077**  
Aluminium couleur Corten, toile tissée moka chiné, plateau latté, Teck massif à la finition Duratek®  
Corten color aluminum, mocha mottled sling, Duratek® finish solid teak slatted top  
1pc/1box 0,366 m<sup>3</sup>  
8,75 kg



TABLE BASSE DURATEK® JET STREAM  
JET STREAM DURATEK® LOW TABLE

**JSTA080**  
Aluminium couleur Corten, toile tissée moka chiné, plateau latté, Teck massif à la finition Duratek®  
Corten color aluminum, mocha mottled sling, Duratek® finish solid teak slatted top  
1pc/1box 0,219 m<sup>3</sup>  
10 kg



MODULE JET STREAM  
JET STREAM CENTRAL SOFA

**JSES017**  
Aluminium gris espace, Batyline Eden blanc chiné  
Space grey aluminum, white grey Eden Batyline  
2pcs/1box 0,265 m<sup>3</sup>  
5 kg

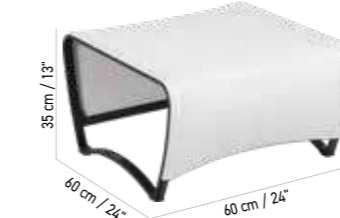

REPOSE PIEDS JET STREAM  
JET STREAM LEGREST

**JSRP047**  
Aluminium gris espace, Batyline Eden blanc chiné  
Space grey aluminum, white grey Eden Batyline  
1pc/1box 0,165 m<sup>3</sup>  
4 kg

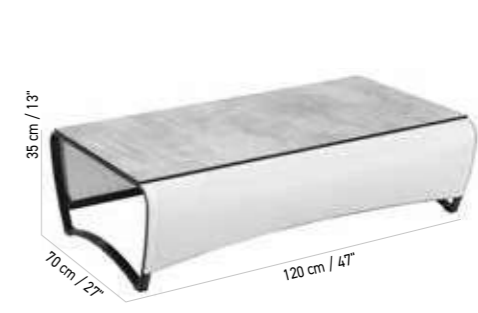

TABLE BASSE HPL JET STREAM  
JET STREAM HPL LOW TABLE

**JSTA069**  
Aluminium gris espace, Batyline Eden blanc chiné, plateau plein HPL béton ciré  
Space grey aluminum, white grey Eden Batyline, white polish concrete HPL top  
1pc/1box 0,366 m<sup>3</sup>  
15 kg



TABLE BASSE HPL JET STREAM  
JET STREAM HPL LOW TABLE

**JSTA054**  
Aluminium gris espace, Batyline Eden blanc chiné, plateau plein HPL béton ciré  
Space grey aluminum, white grey Eden Batyline, white polish concrete HPL top  
1pc/1box 0,219 m<sup>3</sup>  
10 kg



TABLE BASSE LUMINEUSE SOLAIRE ET RECHARGEABLE JET STREAM  
JET STREAM LOW TABLE SOLAR AND RECHARGEABLE LIGHTING

**JSTAL10**  
Aluminium couleur Corten, Teck massif à la finition Duratek®, plaque en verre dépoli acrylique  
Corten color aluminum, Duratek® finish solid teak slatted top, acrylic frosted glass plate  
1pc/3boxes 0,17 m<sup>3</sup>  
15,5 kg



TABLETTE DROITE JET STREAM  
JET STREAM STRAIGHT SHELF

**JSTA021**  
Plateau en teck massif à la finition Duratek®  
Duratek® finish solid teaktop  
1pce/1box 0,032 m<sup>3</sup>  
3,90 kg



JEU D'ACCOUDOIRS JET STREAM  
ARMREST KIT JET STREAM

**JSAC040**  
Aluminium couleur Corten, Teck massif à la finition Duratek®  
Corten color aluminum, Duratek® finish solid teak  
2pcs/1box 0,03 m<sup>3</sup>  
2 kg



TABLETTE D'ANGLE JET STREAM  
JET STREAM CORNER SHELF

**JSTA020**  
Plateau en teck massif à la finition Duratek®  
Duratek® finish solid teaktop  
1pce/1box 0,051 m<sup>3</sup>  
4,85 kg



TABLE BASSE LUMINEUSE SOLAIRE ET RECHARGEABLE JET STREAM  
JET STREAM LOW TABLE SOLAR AND RECHARGEABLE LIGHTING

**JSTAL11**  
Aluminium gris espace, HPL béton ciré, plaque en verre dépoli acrylique, granite  
Space grey aluminum, HPL white wash concrete, acrylic frosted glass plate, granite  
1pc/3boxes 0,17 m<sup>3</sup>  
26,70 kg



TABLETTE DROITE JET STREAM  
JET STREAM STRAIGHT SHELF

**JSTA046**  
Aluminium gris espace, HPL béton ciré  
Space grey aluminum, white polish concrete HPL  
1pc/1box 0,03 m<sup>3</sup>  
4 kg



JEU D'ACCOUDOIRS JET STREAM  
ARMREST KIT JET STREAM

**JSAC028**  
Aluminium gris espace, HPL béton ciré  
Space grey aluminum, white polish concrete HPL  
2pcs/1box 0,035 m<sup>3</sup>  
2 kg



TABLETTE D'ANGLE JET STREAM  
JET STREAM CORNER SHELF

**JSTA045**  
Aluminium gris espace, HPL béton ciré  
Space grey aluminum, white polish concrete HPL  
1pc/1box 0,0349 m<sup>3</sup>  
5 kg



# JET STREAM

TABLES LUMINEUSES  
SOLAIRES ET RECHARGEABLES

TABLE SOLAR AND RECHARGEABLE LIGHTING

ECLAIRAGE  
500  
LUMENS  
BRIGHT 2700 K



TABLE BASSE LUMINEUSE HALO  
HALO ILLUMINATED LOW TABLE



Aluminium gris espace,  
HPL ceramique grise,  
plaque en verre dépoli acrylique  
Space grey aluminum, HPL grey  
ceramic top, acrylic frosted glass plate



Aluminium couleur Corten,  
HPL ceramique lin,  
plaque en verre dépoli acrylique  
Corten color aluminum, HPL linen  
ceramic top, acrylic frosted glass plate

1pc/1box 0,135 m<sup>3</sup>  
5,60 kg



TABLE BASSE LUMINEUSE HALO  
HALO ILLUMINATED LOW TABLE



Aluminium gris espace,  
HPL ceramique grise,  
plaque en verre dépoli acrylique  
Space grey aluminum, HPL grey  
ceramic top, acrylic frosted glass plate



Aluminium couleur Corten,  
HPL ceramique lin,  
plaque en verre dépoli acrylique  
Corten color aluminum, HPL linen  
ceramic top, acrylic frosted glass plate

1pc/1box 0,350 m<sup>3</sup>  
9,85 kg

# BASTINGAGE

Design by Claude Robin



Une collection inspirée du monde du nautisme, robuste et douce dans ses formes grâce à ses tubes en aluminium mélangé au Duratek®.

Bastingage is a tribute to sailing. Strong and soft at the same time, like a ship rail, thanks to its round aluminum shapes and its Duratek® teak insert.

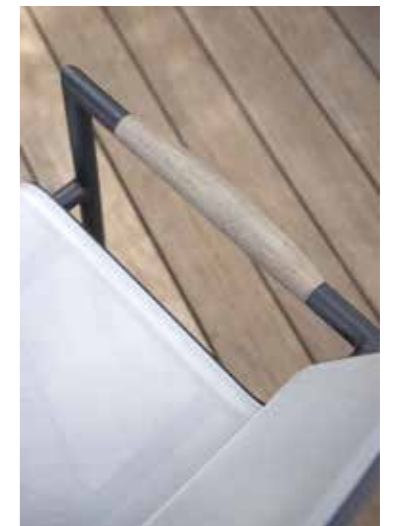

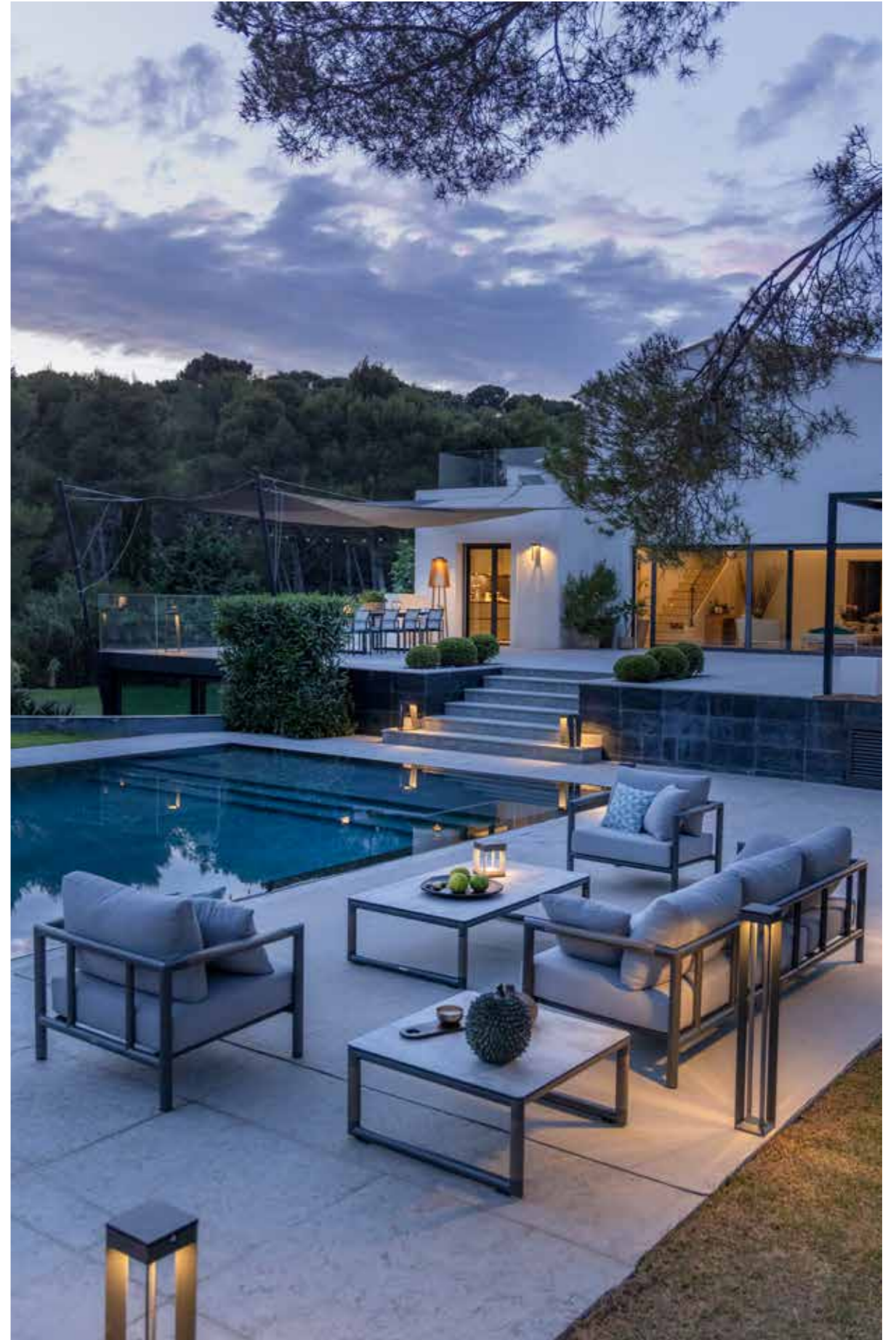



Matières : Aluminium, insert en teck massif à la finition Duratek® sans entretien, toile Ateja chinée, coussinage Ateja, HPL finition béton ciré

Entretien : Les tables et les assises peuvent rester dehors toute l'année. Les coussins sont déperlants mais doivent être hivernés. Nous conseillons de nettoyer le plateau des tables en HPL après chaque repas à l'eau savonneuse ou au nettoyant pour vitres. Ne pas utiliser de produits abrasifs pour l'entretien du Duratek®.

Materials: Aluminum, Duratek® finish solid teak finish insert with no maintenance, Ateja sling and cushions, white wash concrete HPL

Maintenance: Chairs and tables can stay outside all year long. Cushions are water repellent, but need to be stored in winter. It is advisable to clean up the table HPL top after each meal. Do not use abrasive products to clean Duratek®/frames.



**KIOSQUE BASTINGAGE**  
2 COUSSINS ARTICULÉS + COUSSIN CENTRAL INCLUS  
BASTINGAGE BALINESE DAYBED  
TWO CUSHIONS ARTICULATED + CENTRAL CUSHION INCLUDED

DBB6101 + DBBC001

Aluminium blanc, insert Teck massif à la finition Duratek®, toile Ateja blanc chiné, tablette HPL béton ciré, tissu Ateja gris clair  
White aluminum, Duratek® finish solid teak insert, white grey Ateja sling, white wash concrete HPL tablet, light grey Ateja

DBB6102 + DBBC001

Aluminium gris espace, insert Teck massif à la finition Duratek®, toile Ateja blanc chiné, tablette HPL béton ciré, tissu Ateja gris clair  
Space grey aluminum, Duratek® finish solid teak insert, white grey Ateja sling, white wash concrete HPL tablet, light grey Ateja

1pc/2boxes 1,574 m<sup>3</sup>  
97,5 kg

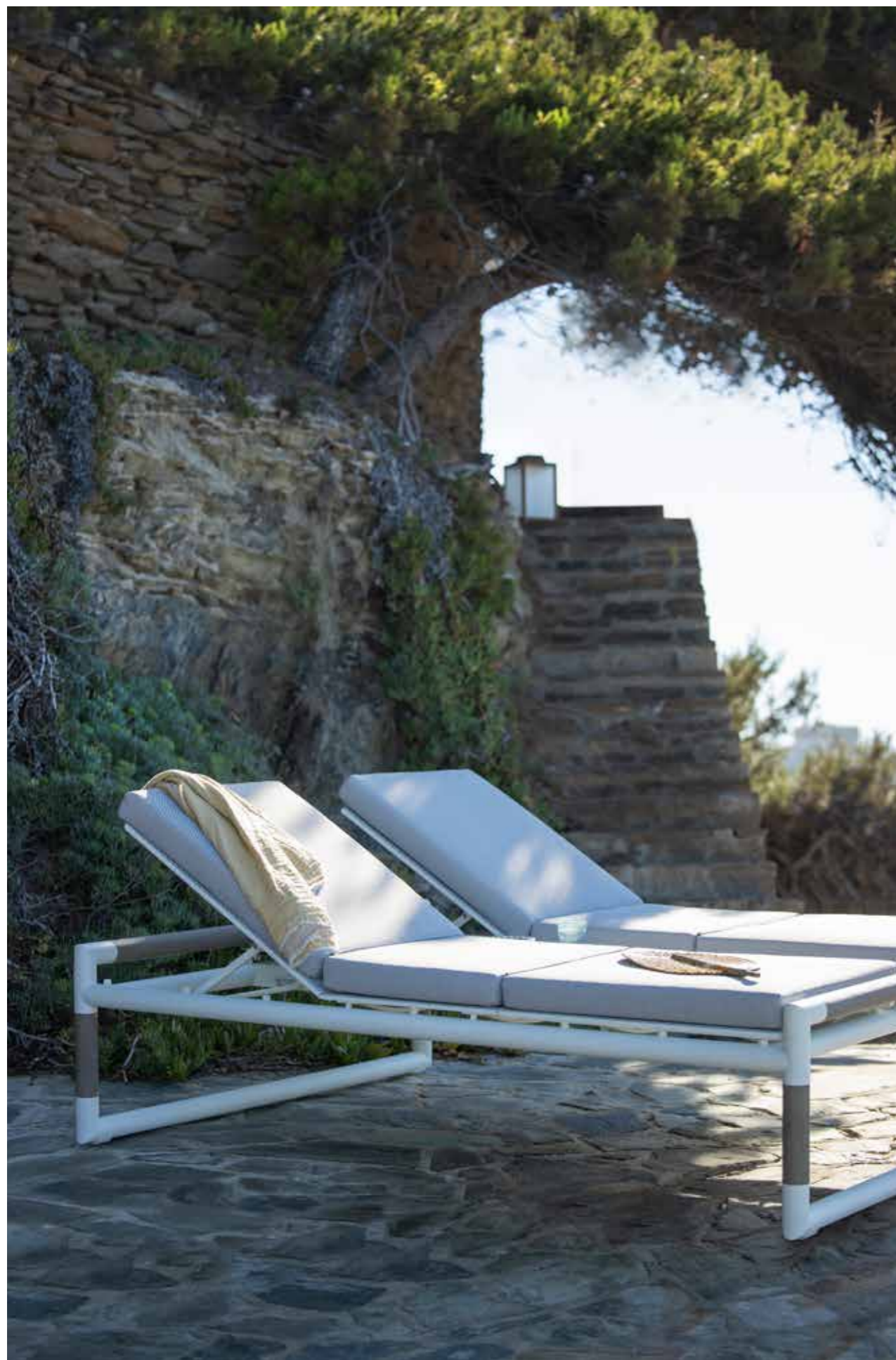

# BASTINGAGE

## BAIN DE SOLEIL, LIT DOUBLE ET COUSSINS

SUNLOUNGER, DOUBLE DAYBED AND CUSHIONS



**BAIN DE SOLEIL EMPILABLE, ROUES ARRIERES BASTINGAGE**  
BASTINGAGE STACKABLE SUNLOUNGER BACKWHEELS



**Aluminium blanc, insert Teck massif à la finition Duratek®, toile Ateja blanc chiné**  
White aluminum, Duratek® finish solid teak insert, white grey Ateja sling

2pcs/1box 0,42 m<sup>3</sup>  
15,5 kg



**Aluminium gris espace, insert Teck massif à la finition Duratek®, toile Ateja blanc chiné**  
Space grey aluminum, Duratek® finish solid teak insert, white grey Ateja sling



**LIT DOUBLE BASTINGAGE 2 COUSSINS ARTICULÉS + COUSSIN CENTRAL INCLUS TROU PARASOL Ø 58 MM**  
BASTINGAGE DOUBLE DAYBED TWO CUSHIONS ARTICULATED + CENTRAL CUSHION INCLUDED UMBRELLA HOLE



**Aluminium blanc, insert Teck massif à la finition Duratek®, tablette HPL béton ciré, tissu Ateja gris clair**  
White aluminum, Duratek® finish solid teak insert, white grey Ateja sling, white wash concrete HPL tablet, light grey Ateja



**Aluminium gris espace, insert Teck massif à la finition Duratek®, toile Ateja blanc chiné, tablette HPL béton ciré, tissu Ateja gris clair**  
Space grey aluminum, Duratek® finish solid teak insert, white grey Ateja sling, white wash concrete HPL tablet, light grey Ateja

1pc/1box 1,102 m<sup>3</sup>  
67 kg

### ACCESSOIRE

APPURTENANCE



**COUSSIN POUR BAIN DE SOLEIL BASTINGAGE**  
CUSHION FOR SUNLOUNGER BASTINGAGE

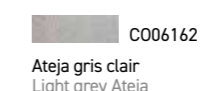

**Ateja gris clair**  
Light grey Ateja

1pc/1box 0,182 m<sup>3</sup>  
5 kg

# BASTINGAGE

## TABLE EXTENSIBLE, FAUTEUIL, CHAISES

EXTENDING TABLE, ARMCHAIR AND CHAIR



TABLE EXTENSIBLE HPL BASTINGAGE x12  
BASTINGAGE HPL EXTENDING TABLE



Aluminium blanc, HPL béton ciré Teck massif à la finition Duratek®  
White aluminum, white wash concrete HPL top Duratek® finish solid teak

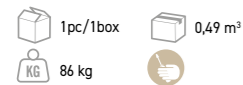

Aluminium gris espace, HPL béton ciré Teck massif à la finition Duratek®  
Space grey aluminum, white wash concrete HPL top Duratek® finish solid teak

FAUTEUIL EMPILABLE BASTINGAGE  
BASTINGAGE STACKABLE ARMCHAIR



Aluminium blanc, accoudoirs Teck massif à la finition Duratek®, toile Ateja blanc chiné  
White aluminum, Duratek® finish solid teak insert, white grey Ateja sling

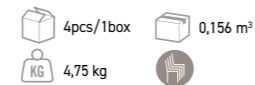

Aluminium gris espace, accoudoirs Teck massif à la finition Duratek®, toile Ateja blanc chiné  
Space grey aluminum, Duratek® finish solid teak insert, white grey Ateja sling

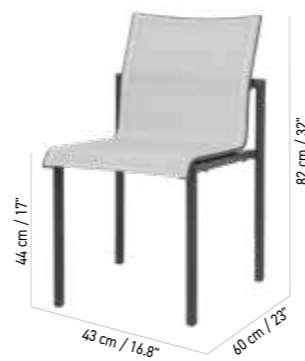
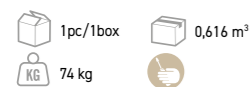

TABLE EXTENSIBLE HPL BASTINGAGE x 8/10  
BASTINGAGE HPL EXTENDING TABLE



Aluminium blanc, HPL béton ciré Teck massif à la finition Duratek®  
White aluminum, white wash concrete HPL top Duratek® finish solid teak



Aluminium gris espace, HPL béton ciré Teck massif à la finition Duratek®  
Space grey aluminum, white wash concrete HPL top Duratek® finish solid teak

CHAISE EMPILABLE BASTINGAGE  
BASTINGAGE STACKABLE CHAIR



Aluminium blanc, insert Teck massif à la finition Duratek®, toile Ateja blanc chiné  
White aluminum, Duratek® finish solid teak insert, white grey Ateja sling

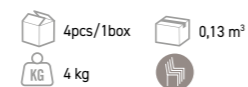

Aluminium gris espace, insert Teck massif à la finition Duratek®, toile Ateja blanc chiné  
Space grey aluminum, Duratek® finish solid teak insert, white grey Ateja sling



# BASTINGAGE

TABLE BISTRO ET MANGE DEBOUT  
BISTRO TABLE AND HIGH DINNING

## 1 - CHOISISSEZ LE PIED - CHOOSE THE FOOT



PIED CENTRAL POUR TABLE BASTINGAGE  
BASTINGAGE CENTRAL FEET



Aluminium blanc,  
Teck massif à la finition Duratek®  
White aluminum,  
Duratek® finish solid teak

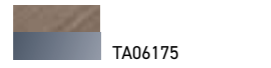
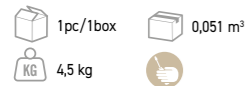

Aluminium gris espace,  
Teck massif à la finition Duratek®  
Space grey aluminum,  
Duratek® finish solid teak



PIED CENTRAL POUR TABLE MANGE DEBOUT BASTINGAGE  
STRUCTURE FOR TABLE HIGH DINNING



Aluminium blanc,  
Teck massif à la finition Duratek®  
White aluminum,  
Duratek® finish solid teak

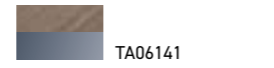
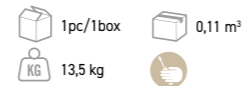

Aluminium gris espace,  
Teck massif à la finition Duratek®  
Space grey aluminum,  
Duratek® finish solid teak



## 2 - CHOISISSEZ LE PLATEAU - CHOOSE THE TOP

PLATEAUX CÉRAMIQUES  
CERAMIC TOP



STRUCTURE POUR PLATEAU CÉRAMIQUE 78X78 CM  
STRUCTURE FOR CERAMIC TABLE 30,7" X 30,7"



Aluminium blanc  
White aluminum



Aluminium gris espace  
Space grey aluminum

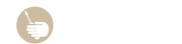

CÉRAMIQUE 75X75 CM RENFORCÉE PAR FIBRAGE POLYESTER ÉPAISSEUR 0,6 CM  
CERAMIC 29,5" X 29,5" POLYESTER FIBER REINFORCEMENT THICKNESS 0,023"



Céramique noire marbre  
Ceramic marble black



Céramique blanche tadelakt  
Ceramic white tadelakt



60 x 60 CM 24" X 24"	70 x 70 CM 27" X 27"	80 x 80 CM 31" X 31"	Ø 80 CM Ø 31"	Ø 90 CM Ø 35"
H306060	H307070	H308080	H300080	H300090
Poids : 5 kg Vol.: 0,021 m³	Poids : 6 kg Vol.: 0,029 m³	Poids : 9 kg Vol.: 0,036 m³	Poids : 9 kg Vol.: 0,035 m³	Poids : 11 kg Vol.: 0,046 m³

Colisages : 1pc/1box

60 x 60 CM 24" X 24"	70 x 70 CM 27" X 27"	80 x 80 CM 31" X 31"	Ø 80 CM Ø 31"	Ø 90 CM Ø 35"
H806060	H807070	H808080	H800080	H800090
Poids : 5 kg Vol.: 0,021 m³	Poids : 6 kg Vol.: 0,029 m³	Poids : 9 kg Vol.: 0,036 m³	Poids : 9 kg Vol.: 0,035 m³	Poids : 11 kg Vol.: 0,046 m³

Colisages : 1pc/1box

PLATEAUX HPL  
HPL TOP



PLATEAU HPL ARDOISE  
SLATE GREY HPL TOP TABLE



PLATEAU HPL BÉTON CIRÉ  
WHITE WASH CONCRETE HPL

■ Références en stock - On Stock - Attention : seules certaines références sont stockées, vous reporter à celles identifiées comme telles. Autres choix p. 71  
Autres références sur commande, nous consulter. Warning : only few references are on stock. Others on special orders

## 1 - CHOISISSEZ LE PIED - CHOOSE THE FOOT



PIED DOUBLE BISTRO BASTINGAGE x 4  
BASTINGAGE TABLE HIGH DINNING



Aluminium blanc,  
Teck massif à la finition Duratek®  
White aluminum,  
Duratek® finish solid teak

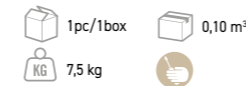

Aluminium gris espace,  
Teck massif à la finition Duratek®  
Space grey aluminum,  
Duratek® finish solid teak



PIEDS DOUBLE MANGE DEBOUT BASTINGAGE x 6  
BASTINGAGE TABLE HIGH DINNING



Aluminium blanc,  
Teck massif à la finition Duratek®  
White aluminum,  
Duratek® finish solid teak

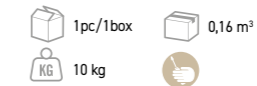

Aluminium gris espace,  
Teck massif à la finition Duratek®  
Space grey aluminum,  
Duratek® finish solid teak

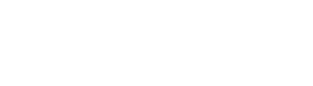

## 2 - CHOISISSEZ LE PLATEAU - CHOOSE THE TOP

PLATEAUX HPL  
HPL TOP



PLATEAU HPL ARDOISE  
SLATE GREY HPL TOP TABLE

110 x 70 CM  
48" X 27"  
H311070

Poids : 11 kg  
Vol.: 0,052 m³

120 x 80 CM  
48" X 31"  
H312080

Poids : 14 kg  
Vol.: 0,054 m³



PLATEAU HPL BÉTON CIRÉ  
WHITE WASH CONCRETE HPL

110 x 70 CM  
48" X 27"  
H811070

Poids : 11 kg  
Vol.: 0,052 m³

120 x 80 CM  
48" X 31"  
H812080

Poids : 14 kg  
Vol.: 0,054 m³

Colisages : 1pc/1box

Colisages : 1pc/1box

TABOURET BASTINGAGE  
BASTINGAGE BAR STOOL



Aluminium blanc, insert  
Teck massif à la finition Duratek®,  
toile Ateja blanc chiné  
White aluminum, insert  
Duratek® finish solid teak,  
white grey Ateja sling



Aluminium gris espace, insert  
Teck massif à la finition Duratek®,  
toile Ateja blanc chiné  
Space grey aluminum, insert  
Duratek® finish solid teak,  
white grey Ateja sling

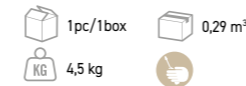

TABLE BISTRO HPL BASTINGAGE x 2  
BASTINGAGE HPL BISTRO TABLE



Aluminium blanc, HPL béton ciré,  
Teck massif à la finition Duratek®  
White aluminum,  
white wash concrete HPL top  
Duratek® finish solid teak



Aluminium gris espace,  
HPL béton ciré,  
Teck massif à la finition Duratek®  
Space grey aluminum,  
white wash concrete HPL top  
Duratek® finish solid teak

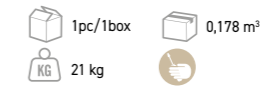

Colisages : 1pc/1box

Colisages : 1pc/1box

# BASTINGAGE

## CANAPÉ, FAUTEUIL ET TABLE BASSE

SOFA, ARMCHAIR AND LOW TABLE



CANAPÉ 3 PLACES BASTINGAGE x 3/4  
BASTINGAGE 3 SEAT SOFA



Aluminium blanc,  
Ateja gris clair  
White aluminum,  
light grey Ateja



Aluminium blanc,  
Sunbrella® natté gris clair  
White aluminum,  
Natte light grey Sunbrella®



Aluminium blanc,  
Sunbrella® lopi gris  
White aluminum,  
grey Sunbrella® Lopi

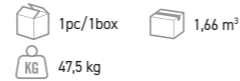

HOUSSE DE PROTECTION  
PROTECTION COVER  
HP03530



Aluminium gris espace,  
Ateja gris clair  
Space grey aluminum,  
light grey Ateja cushions



Aluminium gris espace,  
Sunbrella® natté gris clair  
Space grey aluminum,  
Natte light grey Sunbrella®



Aluminium gris espace,  
Sunbrella® lopi gris  
Space grey aluminum,  
grey Sunbrella® Lopi

Tous les inserts sont en Teck massif à la finition Duratek®  
All inserts are Duratek® finish solid teak

+ Duratek® : notre teck massif sans entretien / our maintenance-free solid teak



CANAPÉ 2 PLACES BASTINGAGE x 2  
BASTINGAGE 2 SEAT SOFA



Aluminium blanc,  
cousins Ateja gris clair  
White aluminum,  
light grey Ateja cushions

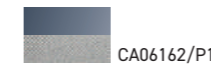

Aluminium gris espace,  
cousins Ateja gris clair  
Space grey aluminum,  
light grey Ateja cushions



Aluminium blanc,  
Sunbrella® natté gris clair  
White aluminum,  
Natte light grey Sunbrella®



Aluminium gris espace,  
Sunbrella® natté gris clair  
Space grey aluminum,  
Natte light grey Sunbrella®



Aluminium blanc,  
Sunbrella® lopi gris  
White aluminum,  
grey Sunbrella® Lopi



Aluminium gris espace,  
Sunbrella® lopi gris  
Space grey aluminum,  
grey Sunbrella® Lopi



HOUSSE DE PROTECTION  
PROTECTION COVER  
HP03531



FAUTEUIL CLUB BASTINGAGE  
BASTINGAGE ARMCHAIR



Aluminium blanc,  
cousins Ateja gris clair  
White aluminum,  
light grey Ateja cushions

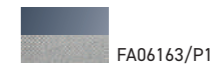

Aluminium gris espace,  
cousins Ateja gris clair  
Space grey aluminum,  
light grey Ateja cushions



Aluminium blanc,  
Sunbrella® natté gris clair  
White aluminum,  
Natte light grey Sunbrella®



Aluminium gris espace,  
Sunbrella® natté gris clair  
Space grey aluminum,  
Natte light grey Sunbrella®



Aluminium blanc,  
Sunbrella® lopi gris  
White aluminum,  
grey Sunbrella® Lopi



Aluminium gris espace,  
Sunbrella® lopi gris  
Space grey aluminum,  
grey Sunbrella® Lopi



HOUSSE DE PROTECTION  
PROTECTION COVER  
HP03535



# BASTINGAGE

## ENSEMBLE BAS

LOW



**FAUTEUIL BAS EMPILABLE BASTINGAGE**  
BASTINGAGE LOW STACKABLE ARMCHAIR



Aluminium blanc, toile Ateja blanc chiné  
White aluminum, armrest white grey Ateja sling



Aluminium gris espace, toile Ateja blanc chiné  
Space grey aluminum, white grey Ateja sling



**CANAPÉ EMPILABLE BASTINGAGE** x 2  
BASTINGAGE 2 SEAT STACKABLE SOFA



Aluminium blanc, toile Ateja blanc chiné  
White aluminum, armrest white grey Ateja sling



Aluminium gris espace, toile Ateja blanc chiné  
Space grey aluminum, white grey Ateja sling

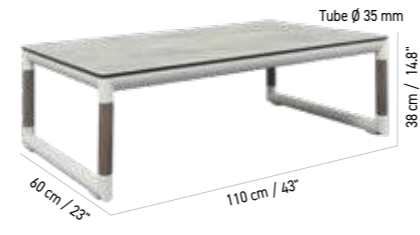

**TABLE BASSE HPL (L) BASTINGAGE**  
BASTINGAGE HPL LOW TABLE (L SIZE)



Aluminium blanc, HPL béton ciré  
White aluminum, white wash concrete HPL top



Aluminium gris espace, HPL béton ciré  
Space grey aluminum, white wash concrete HPL top

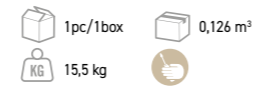

**TABLE BASSE HPL (XL) BASTINGAGE**  
BASTINGAGE HPL LOW TABLE (XL SIZE)



Aluminium blanc, HPL béton ciré  
White aluminum, white wash concrete HPL top

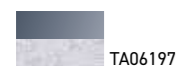

Aluminium gris espace, HPL béton ciré  
Space grey aluminum, white wash concrete HPL top

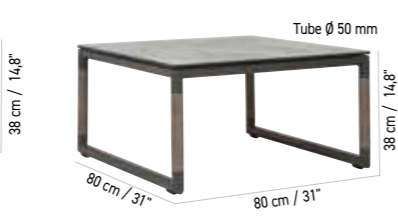
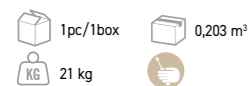

**TABLE BASSE HPL (M) BASTINGAGE**  
BASTINGAGE HPL LOW TABLE IN (MEDIUM SIZE)



Aluminium blanc, HPL béton ciré  
White aluminum, white wash concrete HPL top



Aluminium gris espace, HPL béton ciré  
Space grey aluminum, white wash concrete HPL top

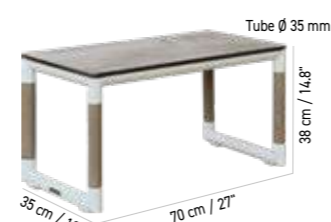
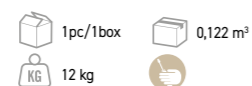

**TABLE BASSE HPL (S) BASTINGAGE**  
BASTINGAGE HPL LOW TABLE (SMALL SIZE)



Aluminium blanc, HPL béton ciré  
White aluminum, white wash concrete HPL top

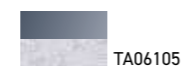

Aluminium gris espace, HPL béton ciré  
Space grey aluminum, white wash concrete HPL top

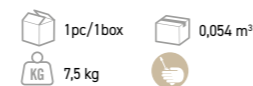

# RANCHO



Intemporel est le mot qui caractérise cette collection graphique et contemporaine. Elle peut aussi bien habiller des lieux modernes qu'authentiques. Rancho est une collection XXL par ses dimensions et son confort.

Timeless is the word that characterizes this graphic and contemporary collection. It can be used in modern and authentic places. Rancho is an XXL collection by its dimensions and its comfort.





Matières : Aluminium, teck massif à la finition Duratek® sans entretien, céramique, coussinage et tissu Ateja copacabana.

Entretien : Le Duratek® ne nécessite pas d'entretien et peut rester dehors toute l'année sans altération de sa couleur. Les coussins sont déperlants mais doivent être hivernés. Nous conseillons de nettoyer le plateau des tables ou céramiques après chaque repas à l'eau savonneuse ou au nettoyant pour vitres. Ne pas utiliser de produits abrasifs pour l'entretien du Duratek®.

Materials: Aluminum, solid teak Duratek® finish with no maintenance, ceramics, Ateja copacabana cushion fabric, White wash concrete HPL.

Maintenance: The Duratek® doesn't need maintenance, it can stay outside all year long, just like the Batyline sling chairs. Cushions are water repellent, but need to be stored in winter. It is advisable to clean up the table HPL or ceramic tops after each meal. Do not use abrasive products to clean Duratek®/frames.

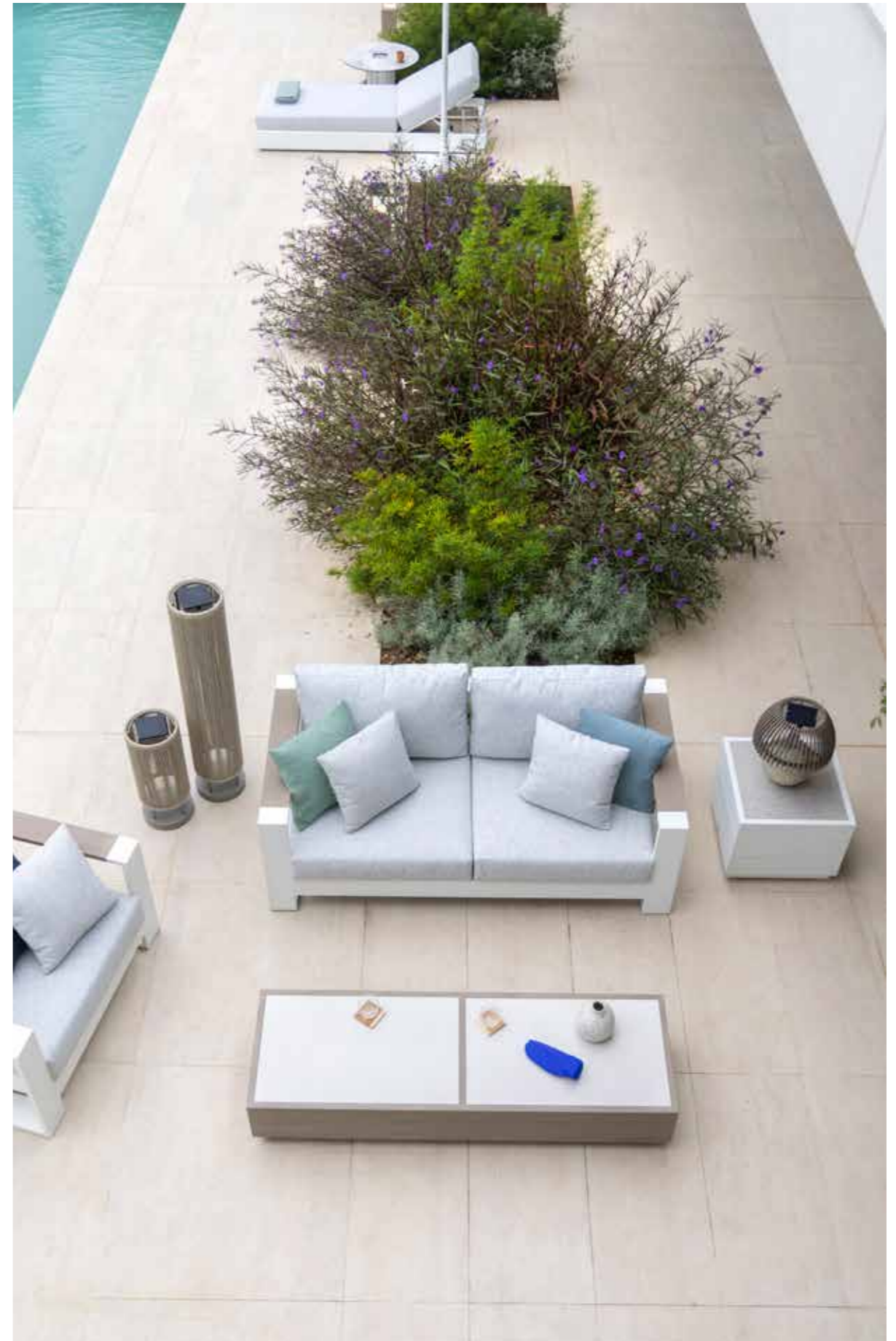

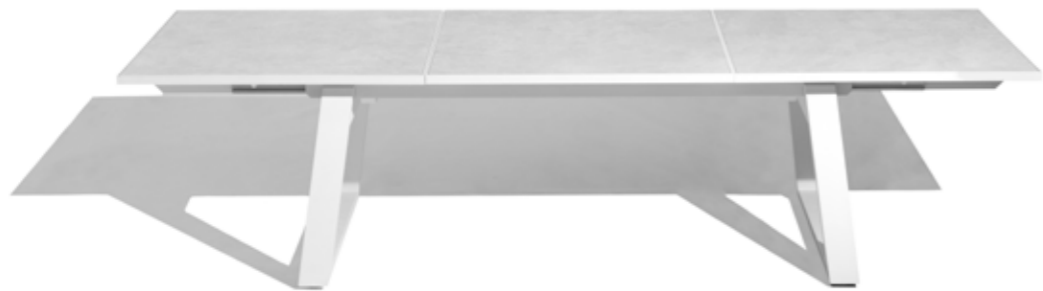

# RANCHO

## TABLE, FAUTEUIL, CHAISE ET TABOURET

TABLE, ARMCHAIR, CHAIR AND STOOL



TABLE EXTENSIBLE CÉRAMIQUE RANCHO x 10/12  
PAR SYSTEME DE LEVIER  
EXTENDABLE TABLE CERAMIC RANCHO WITH LEVER SYSTEM

TA02102/P1  
Aluminium blanc, Céramique béton ciré  
White aluminum, White polished concrete ceramic  
4pcs/2boxes 0,79 m³  
85,5 kg



FAUTEUIL EMPILABLE, TRESSÉE RANCHO  
RANCHO STACKABLE ROPE ARMCHAIR

FA07021\*  
Aluminium gris espace, teck massif à la finition Duratek®, corde plate grafito  
Space grey aluminum, Duratek® finish solid teak, grafito flat rope

4pcs/1box 0,126 m³  
4,60 kg

FA07022\*  
Aluminium blanc, teck massif à la finition Duratek®, corde plate gris chiné  
Space grey aluminum, Duratek® finish solid teak, mixed grey flat rope

CHAISE EMPILABLE, TRESSÉE RANCHO  
RANCHO STACKABLE ROPE CHAIR

CH07021\*  
Aluminium gris espace, corde plate grafito  
Space grey aluminum, grafito flat rope

4pcs/1box 0,11 m³  
3,80 kg

CH07022\*  
Aluminium blanc, corde plate gris chiné  
Space grey aluminum, mixed grey flat rope



MANGE DEBOUT CÉRAMIQUE RANCHO x 6  
PIEDS DOUBLE  
HIGH DINING DOUBLE FEET, FIXED TOP, RANCHO

FAPR2300/P1 Aluminium gris espace, Céramique béton ciré  
Space grey aluminum, White polished concrete ceramic

FAPR2300/P2 Aluminium gris espace, Céramique marbre noir  
Space grey aluminum, Ceramic marble black

FAPR2301/P3 Aluminium blanc, Céramique béton ciré  
White aluminum, White polished concrete ceramic

FAPR2301/P4 Aluminium blanc, Céramique marbre noir  
White aluminum, Ceramic marble black

2pcs/3boxes 0,279 m³  
23,73 kg



TABOURET TRESSÉE RANCHO  
RANCHO STOOL ROPE

TAB2100\*  
Aluminium blanc, corde plate gris chiné  
Space grey aluminum, mixed grey flat rope

1pc/1box 0,305 m³  
4,05 kg

TAB2200\*  
Aluminium gris espace, corde plate grafito  
Space grey aluminum, grafito flat rope



\* Ces produits sont disponibles sur commande. These products are available to order.

\* Ces produits sont disponibles sur commande. These products are available to order.

# RANCHO

CANAPÉ, FAUTEUIL, TABLE BASSE  
SOFA, ARMCHAIR, LOW TABLE



CANAPÉ 3 PLACES RANCHO x 3/4  
RANCHO 3 SEATS SOFA



Aluminium blanc, teck massif à la finition Duratek®, Ateja copacobana gris chiné, White aluminum, Duratek® finish solid teak, white grey copacobana Ateja

1pc/1box  
53,30 kg

1,825 m³

HOUSSE DE PROTECTION  
PROTECTION COVER  
HP03550

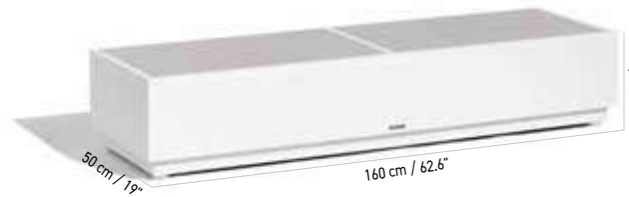

TABLE BASSE CÉRAMIQUE (L) RANCHO  
RANCHO CERAMIC LOW TABLE (LARGE SIZE)



Aluminium blanc, céramique belgium gris clair, White aluminum, belgium light grey ceramic

1pc/1box  
20,45 kg

0,398 m³



TABLE BASSE CÉRAMIQUE (L) RANCHO  
RANCHO CERAMIC LOW TABLE (LARGE SIZE)



Teck massif à la finition Duratek®, céramique ciment blanc, Duratek® finish solid teak, white cement ceramic

1pc/1box  
23,90 kg

0,398 m³

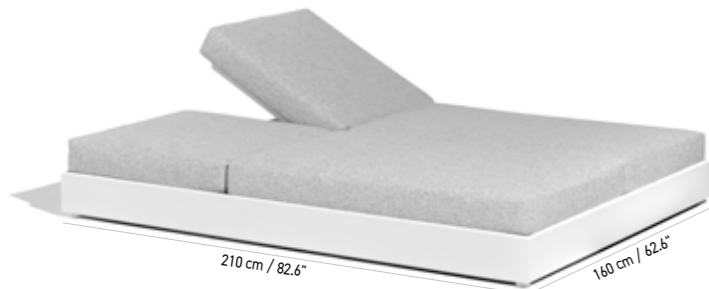

LIT DOUBLE DE JARDIN RANCHO  
RANCHO DOUBLE LOUNGER



Aluminium blanc, Ateja copacobana gris chiné, White aluminum, white grey copacobana Ateja

1pc/1box  
57,35 kg

1,36 m³



LIT SINGLE DE JARDIN RANCHO  
RANCHO SINGLE LOUNGER



Aluminium blanc, Ateja copacobana gris chiné, White aluminum, white grey copacobana Ateja

1pc/1box  
31,25 kg

0,737 m³



CANAPÉ 2 PLACES RANCHO x 2/3  
RANCHO 2 SEATS SOFA



Aluminium blanc, teck massif à la finition Duratek®, Ateja copacobana gris chiné, White aluminum, Duratek® finish solid teak, white grey copacobana Ateja

1pc/1box  
39,5 kg

1,293 m³

HOUSSE DE PROTECTION  
PROTECTION COVER  
HP03551



TABLE BASSE CÉRAMIQUE (M) RANCHO  
RANCHO CERAMIC LOW TABLE (MEDIUM SIZE)



Aluminium blanc, Céramique béton ciré, White aluminum, White polished concrete ceramic

1pc/2boxes  
19,73 kg

0,403 m³



FAUTEUIL CLUB RANCHO  
RANCHO CLUB ARMCHAIR



Aluminium blanc, teck massif à la finition Duratek®, Ateja copacobana gris chiné, White aluminum, Duratek® finish solid teak, white grey copacobana Ateja

1pc/1box  
31,25 kg

0,79 m³

HOUSSE DE PROTECTION  
PROTECTION COVER  
HP03552



TABLE BASSE CÉRAMIQUE (XL) RANCHO  
RANCHO CERAMIC LOW TABLE (XL SIZE)



Aluminium blanc, Céramique béton ciré, White aluminum, White polished concrete ceramic

1pc/3boxes  
24,13 kg

0,706 m³



TABLE BASSE CÉRAMIQUE (S) RANCHO  
RANCHO CERAMIC LOW TABLE (SMALL SIZE)



Aluminium blanc, céramique belgium gris clair, White aluminum, belgium light grey ceramic

1pc/1box  
13,30 kg

0,228 m³



TABLE BASSE LUMINEUSE SOLAIRE ET RECHARGEABLE RANCHO  
RANCHO LOW TABLE SOLAR AND RECHARGEABLE LIGHTING



teck massif à la finition Duratek®, plaque en verre dépoli acrylique, Duratek® finish solid teak, acrylic plate frosted glass

1pc/1box  
6 kg

0,133 m³

# AMAKA



Une collection à l'esthétique épurée, fabriquée pour la praticité et le confort. Des tables de toutes tailles pour tous les extérieurs et des assises robustes et confortables.

The oblique lines gives AMAKA this sculptural look that will add an artistic touch to your outdoor living spaces.



Matières : Aluminium, HPL, céramique italienne, toile Ateja.  
Entretien : Pas d'entretien sur les assises et nous conseillons de nettoyer le plateau des tables en HPL après chaque repas à l'eau savonneuse ou au nettoyant pour vitres. Les tables en céramique ne nécessitent pas d'entretien particulier.

Materials: Aluminum, HPL, Italian ceramics, Ateja sling.  
Maintenance: Chairs and tables can stay outside all year long. It is advisable to clean up the table HPL top after each meal.

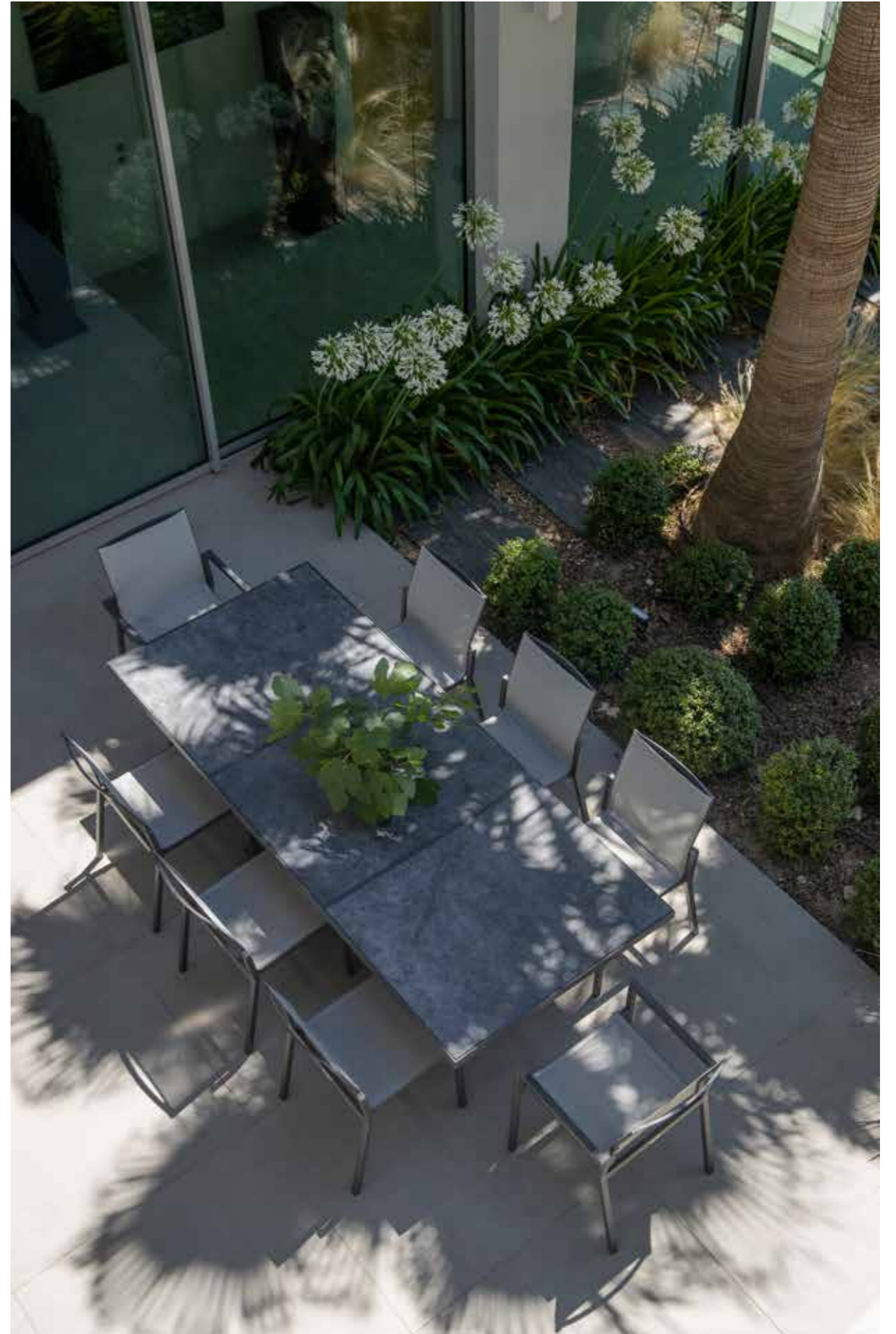



**BAIN DE SOLEIL EMPILABLE AMAKA ROUES ARRIÈRES**  
 AMAKA STACKABLE SUNLOUNGER BACKWHEELS

- 

**TR00986**  
 Aluminium couleur Corten,  
 toile tissée moka chiné  
 Corten color aluminum,  
 mocha mottled sling
- 

**TR00987**  
 Aluminium gris espace,  
 toile Ateja gris clair  
 Space grey aluminum,  
 light grey Ateja sling
- 

**TR00988**  
 Aluminium blanc,  
 toile Ateja gris clair  
 White aluminum,  
 light grey Ateja sling

2pcs/1box 0,328 m<sup>3</sup>  
 KG 12 kg

# AMAKA ALUMINIUM, HPL ET TOILE ATEJA

ALUMINUM, HPL AND ATEJA SLING



**TABLE BALCON EXTENSIBLE HPL TICAO** x 4 / 6  
 TICAO HPL BALCONY EXTENDING TABLE

- 

**TA03600**  
 Aluminium gris espace,  
 plateau plein HPL céramique grise  
 Space grey aluminum,  
 full grey ceramic HPL top
- 

**TA03601**  
 Aluminium blanc,  
 plateau plein HPL béton ciré  
 White aluminum,  
 full white polish concrete HPL top

1pc/1box 0,192 m<sup>3</sup>  
 KG 30 kg



**CHAISE PLIANTE AMAKA**  
 AMAKA FOLDING CHAIR

- 

**CH00211**  
 Aluminium gris espace,  
 toile PVC gris clair  
 Space grey aluminum,  
 light grey Ateja sling
- 

**CH00212**  
 Aluminium blanc,  
 toile Ateja gris clair  
 White aluminum,  
 light grey Ateja sling

2pcs/1box 0,07 m<sup>3</sup>  
 KG 3,5 kg



**+** Toile matelassée séchage rapide  
 Padded canvas

**FAUTEUIL MATELASSE QDF AMAKA**  
 AMAKA ARMCHAIR IN QDF

- 

**FA02064**  
 Aluminium gris espace,  
 Olefin gris clair  
 Space grey aluminum,  
 light grey Olefin

4 pcs/1box 0,23 m<sup>3</sup>  
 KG 5 kg



**TABLE BASSE AMAKA**  
 AMAKA LOW TABLE

- 

**TA01990**  
 Aluminium gris espace,  
 HPL céramique grise  
 Space grey aluminum,  
 grey ceramic HPL
- 

**TA01991**  
 Aluminium blanc,  
 HPL béton ciré  
 White aluminum,  
 white wash concrete HPL

1pc/1box 0,064 m<sup>3</sup>  
 KG 3,5 kg

**TABOURET AMAKA**  
 AMAKA BAR STOOL

- 

**TAB2060**  
 Aluminium gris espace,  
 toile Ateja gris clair  
 Space grey aluminum,  
 light grey Ateja sling

- 

**TAB2061**  
 Aluminium blanc,  
 toile Ateja gris clair  
 White aluminum,  
 light grey Ateja sling

1pc/1box 0,305 m<sup>3</sup>  
 KG 3,5 kg





STRUCTURE DE TABLE EXTENSIBLE PAR SYSTÈME DE LEVIER x 8/10  
STRUCTURE FOR TABLE EXTENDING WITH LEVER SYSTEM

- TA03927**  
Aluminium gris espace  
Space grey aluminum
- TA03919**  
Aluminium couleur Corten,  
Corten color aluminum
- TA03924**  
Aluminium blanc  
White aluminum

1pc/1box 0,524 m<sup>3</sup>  
24,5 kg

CHAISE EMPILABLE AMAKA  
AMAKA STACKABLE CHAIR

- CH02057**  
Aluminium gris espace,  
toile Ateja gris clair,  
Space grey aluminum frame,  
light grey Ateja sling
- CH02058**  
Aluminium blanc,  
toile Ateja gris clair  
White aluminum frame,  
light grey Ateja sling

- CH02020**  
Aluminium muscade,  
toile lin,  
Nutmeg aluminum,  
linen sling
- CH02055**  
Aluminium couleur Corten, toile crème,  
insert Teck massif à la finition Duratek®  
Corten color aluminum, cream canvas,  
Duratek® finish solid teak insert

4pcs/1box 0,11 m<sup>3</sup>  
3 kg

CÉRAMIQUE 80X100 CM RENFORCÉES PAR FIBRAGE POLYESTER ÉPAISSEUR 0,6 CM  
CERAMICS 31.4" X 39.33" POLYESTER FIBER REINFORCEMENT THICKNESS 0,023"

- CER6201**  
Céramique noire marbre  
Ceramic marble black
- CER6023**  
Céramique béton ciré  
Ceramic white polished concrete
- CER6025**  
Céramique ardoise  
Ceramic top slate grey
- CER6101**  
Céramique blanche tadelakt  
Ceramic white tadelakt

3pcs/1box 0,044 m<sup>3</sup>  
38 kg



STRUCTURE DE TABLE EXTENSIBLE PAR SYSTÈME DE LEVIER x 10/12  
STRUCTURE FOR TABLE EXTENDING WITH LEVER SYSTEM

- TA03926**  
Aluminium gris espace  
Space grey aluminum
- TA03918**  
Aluminium couleur Corten,  
Corten color aluminum
- TA03925**  
Aluminium blanc  
White aluminum
- CER6200**  
Céramique noire marbre  
Ceramic marble black
- CER6022**  
Céramique béton ciré  
Ceramic white polished concrete
- CER6020**  
Céramique ardoise  
Ceramic top slate grey
- CER6021**  
Céramique blanche tadelakt  
Ceramic white tadelakt

1pc/1box 0,644 m<sup>3</sup>  
32 kg

3pcs/1box 0,055 m<sup>3</sup>  
48 kg



FAUTEUIL EMPILABLE AMAKA  
STACKABLE AMAKA ARMCHAIR

- FA02053**  
Aluminium gris espace,  
toile Ateja gris clair,  
Space grey aluminum frame,  
light grey Ateja sling
- FA02052**  
Aluminium blanc,  
toile Ateja gris clair  
White aluminum frame,  
light grey Ateja sling
- FA02055**  
Aluminium muscade,  
toile lin,  
Nutmeg aluminum,  
linen sling
- FA02046**  
Aluminium couleur Corten, toile crème,  
insert Teck massif à la finition Duratek®  
Corten color aluminum, cream canvas,  
Duratek® finish solid teak insert

4pcs/1box 0,118 m<sup>3</sup>  
4 kg



TABLE EXTENSIBLE HPL PLATEAU LATTÉ AMAKA x 10/12  
ALLONGE PAR SYSTÈME DE LEVIER  
AMAKA HPL EXTENDING TABLE WITH LEVER SYSTEM

- TA03804**  
Aluminium gris espace,  
HPL céramique grise  
Space grey aluminum,  
grey ceramic HPL slats
- TA03803**  
Aluminium blanc,  
plateau latté en HPL béton ciré  
White aluminum,  
white wash concrete HPL slats

1pc/1box 0,666 m<sup>3</sup>  
76 kg

# SAGAMORE & KOTON

Design by Denali<sup>®</sup>

Des tables cossues et généreuses tout en rondeur, créées pour passer de bons moments.  
Rectangulaires ou carrées mais toujours extensibles.  
Generous tables for special moments. Rectangular or square: always extending.





Matières : Aluminium, HPL, Batyline, toile

Entretien : Nous conseillons de nettoyer le plateau des tables en HPL après chaque repas à l'eau savonneuse ou au nettoyant pour vitres.

Materials: Aluminum, HPL, Batyline, Canvas

Maintenance: It is advisable to clean up the table HPL top after each meal.



TABLE BASSE LUMINEUSE PASTEK SOLAIRE ET RECHARGEABLE  
PASTEK LOW TABLE SOLAR AND RECHARGEABLE LIGHTING



TA00430

HPL ardoise, granite, plaque en verre dépoli acrylique  
HPL slate grey, granit, acrylic plate frosted glass



1pc/3 boxes



0,116 m<sup>3</sup>



18,65 kg



# SAGAMORE & KOTON ALUMINIUM, HPL, TOILE ET DURATEK®

ALUMINIUM, HPL, CANVAS AND DURATEK®



TABLE EXTENSIBLE HPL SAGAMORE X10 / 12  
AVEC ALLONGE PAPILLON  
SAGAMORE HPL EXTENDING TABLE WITH BUTTERFLY EXTENSION



Aluminium blanc,  
HPL béton ciré  
White aluminum,  
white wash concrete HPL top

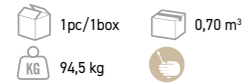

Aluminium gris espace,  
HPL béton ciré  
Space grey aluminum,  
white wash concrete HPL top

FAUTEUIL HAUT DOSSIER EMPILABLE KOTON  
KOTON HIGH STACKABLE DINING ARMCHAIR

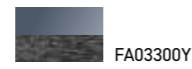

Aluminium gris espace,  
toile tissée grafito  
Space grey aluminum,  
slate grey canvas

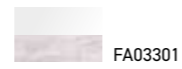

Aluminium blanc,  
Batyline Eden blanc chiné  
White aluminum,  
white grey Eden Batyline

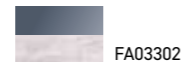

Aluminium gris espace, Batyline Eden  
blanc chiné  
Space grey aluminum,  
white grey Eden Batyline

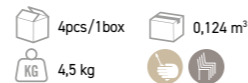

FAUTEUIL LOUNGE EMPILABLE KOTON  
KOTON LOUNGE ARMCHAIR STACKABLE

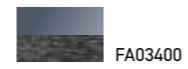

Aluminium gris espace,  
toile tissée grafito  
Space grey aluminum,  
slate grey canvas

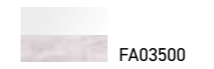
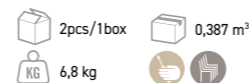

Aluminium blanc,  
Batyline Eden blanc chiné  
White aluminum,  
white grey Eden Batyline

REPOSE PIED KOTON  
FOOT STOOL KOTON

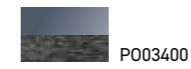

Aluminium gris espace,  
toile tissée grafito  
Space grey aluminum,  
slate grey canvas

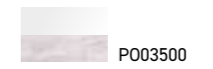
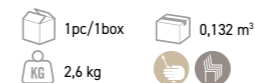

Aluminium blanc,  
Batyline Eden blanc chiné  
White aluminum,  
white grey Eden Batyline

TABLE BASSE HPL KOTON  
COFFEE TABLE HPL KOTON



Aluminium gris espace,  
HPL ardoise  
Space grey aluminum,  
HPL slate grey



Aluminium blanc,  
HPL béton ciré  
White aluminum,  
concrete HPL



TABLE CARRÉE EXTENSIBLE HPL SAGAMORE x 6 / 10  
SAGAMORE HPL SQUARE EXTENDING TABLE

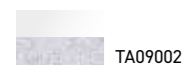

Aluminium blanc,  
HPL béton ciré  
White aluminum,  
white wash concrete HPL top



Aluminium gris espace,  
HPL béton ciré  
Space grey aluminum,  
white wash concrete HPL top

CHAISE HAUT DOSSIER EMPILABLE KOTON  
KOTON HIGH STACKABLE DINING CHAIR

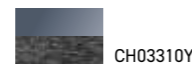

Aluminium gris espace,  
toile tissée grafito  
Space grey aluminum,  
slate grey canvas

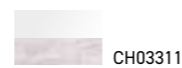

Aluminium blanc,  
Batyline Eden blanc chiné  
White aluminum,  
white grey Eden Batyline



Aluminium gris espace,  
Batyline Eden blanc chiné  
Space grey aluminum,  
white grey Eden Batyline

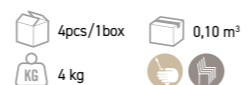
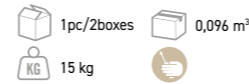

TABLE BASSE LUMINEUSE TECKALU SOLAIRE ET RECHARGEABLE  
TECKALU LOW TABLE SOLAR AND RECHARGEABLE LIGHTING



Aluminium noir, HPL ardoise,  
Teck massif à la finition Duratek®,  
plaque en verre dépoli acrylique  
Black aluminum, slate grey HPL,  
Duratek® finish solid teak,  
acrylic frosted glass plate



Aluminium blanc, HPL béton ciré,  
Teck massif à la finition Duratek®,  
plaque en verre dépoli acrylique  
White aluminum, white wash concrete  
HPL, Duratek® finish solid teak,  
acrylic frosted glass plate

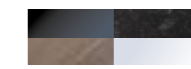

Aluminium noir, HPL ardoise,  
Teck massif à la finition Duratek®,  
plaque en verre dépoli acrylique  
Black aluminum, slate grey HPL,  
Duratek® finish solid teak,  
acrylic frosted glass plate

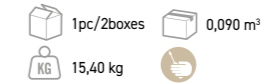

Aluminium blanc, HPL béton ciré,  
Teck massif à la finition Duratek®,  
plaque en verre dépoli acrylique  
White aluminum, white wash concrete  
HPL, Duratek® finish solid teak,  
acrylic frosted glass plate

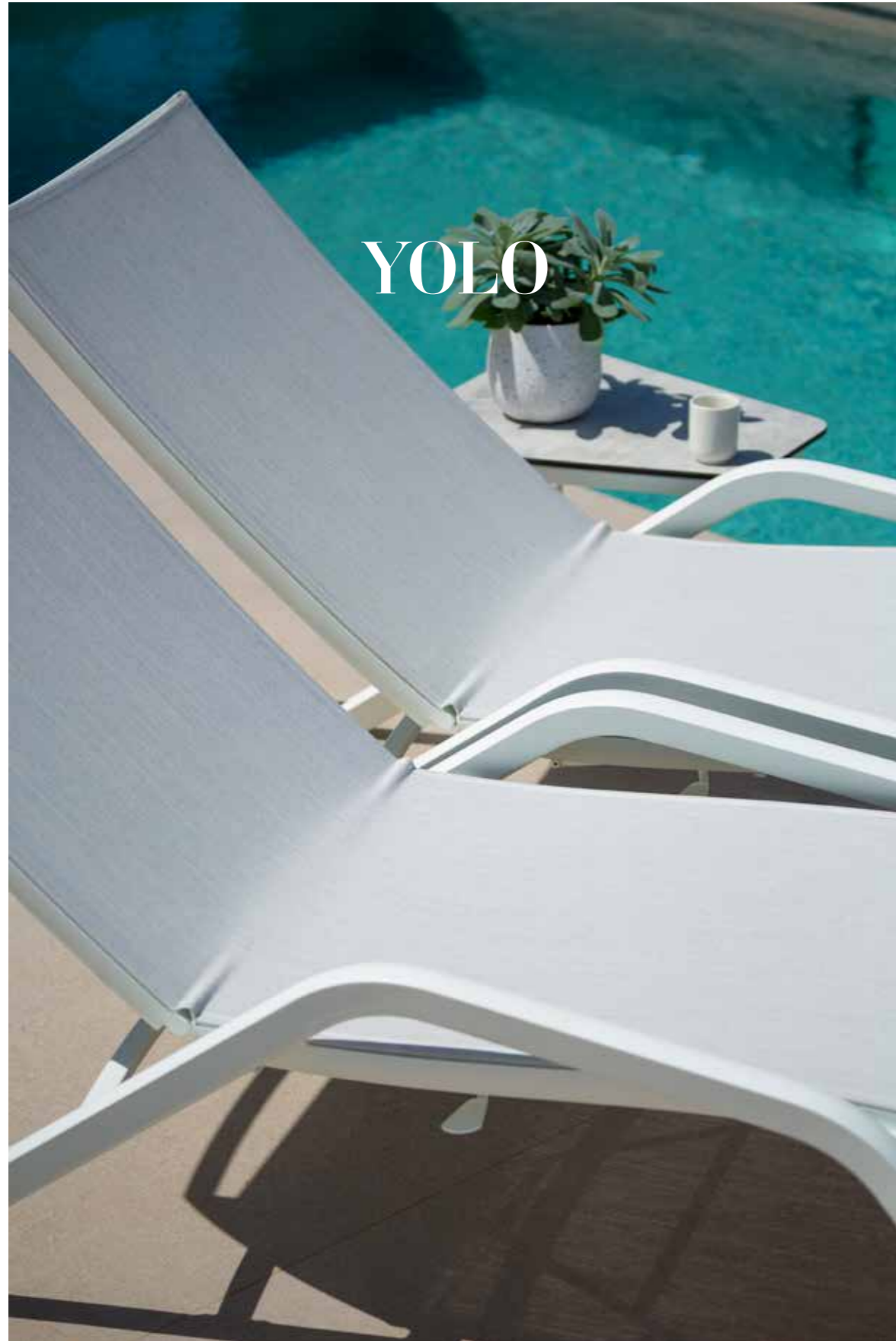



# YOLO

ALUMINIUM, HPL ET TOILE  
ALUMINUM, HPL AND CANVAS



BAIN DE SOLEIL EMPILABLE YOLO AVEC ACCOUDOIRS, ROUES ARRIÈRES, SYSTÈME DE RÉGLAGE ULTRA RAPIDE  
YOLO STACKABLE CHAISE EASY ADJUSTING BACK SEAT SYSTEM, BACKWHEELS

-  **TR01011**  
Aluminium gris espace, Batyline ardoise  
Space grey aluminum, slate grey Batyline
-  **TR01013**  
Aluminium muscade, Batyline lin  
Muscade aluminum, linen Batyline

 1pc/1box  0,307 m³  
 12 kg 





BAIN DE SOLEIL EMPILABLE YOLO AVEC ACCOUDOIRS, ROUES ARRIÈRES, SYSTÈME DE RÉGLAGE ULTRA RAPIDE  
YOLO STACKABLE CHAISE, EASY ADJUSTING BACK SEAT SYSTEM, BACKWHEELS

-  **TR01026**  
Aluminium gris espace, Batyline Eden blanc chiné  
Space grey aluminum, white grey Eden Batyline

 1pc/1box  0,307 m³  
 12 kg 



TABLE BASSE HPL YOLO  
YOLO HPL COFFEE TABLE

-  **TA01092**  
Aluminium gris espace, HPL ceramique grise  
Space grey aluminum, ceramic HPL
-  **TA01097**  
Aluminium gris espace, HPL béton ciré  
Space grey aluminum, white polish concrete HPL

 **TA01098**  
Aluminium blanc, HPL béton ciré  
White aluminum, white polish concrete HPL

 2pcs/1box  0,071 m³  
 5,5 kg



# BISTRO

Modularité et praticité au service des professionnels comme des particuliers.

Matières : Aluminium, HPL, céramique italienne.

Entretien : Nous conseillons de nettoyer le plateau des tables en HPL après chaque repas à l'eau savonneuse ou au nettoyant pour vitres. Les tables en céramique ne nécessitent pas d'entretien particulier.

Our bistro range has been expertly created for hospitality, but also to optimize the space on terraces and balconies.

Materials: Aluminum, HPL and Italian ceramics.

Maintenance: It is advisable to clean up the table HPL tops after each meal. Ceramic tables do not require special maintenance.



**PIED CENTRAL DOUBLE RABATTABLE POUR PLATEAU HPL RECTANGLE**  
CENTRAL DOUBLE FOLDING LEG FOR RECTANGULAR TOP TABLE

**PIED MANGE DEBOUT 4 BRANCHES ENCASTRABLE AVEC TÊTE BASCULANTE**  
CENTRAL LEG WITH TILTING HEAD FOR BAR TABLE

**PIED 4 BRANCHES ENCASTRABLE, AVEC TÊTE BASCULANTE**  
CENTRAL LEG WITH TILTING HEAD

**PIED CENTRAL BISTRO XENAH**  
XENAH BISTRO CENTRAL

**FAPR990**  
Aluminium gris espace  
Space grey aluminum

**FAPR986**  
Aluminium Marron  
Brown aluminum

**FAPR972**  
Aluminium blanc  
White aluminum

1pc/1box 0,151 m<sup>3</sup>  
14 kg

**FAPR975**  
Aluminium gris espace  
Space grey aluminum

**FAPR968**  
Aluminium couleur Corten,  
Corten color aluminum

**FAPR998**  
Aluminium Marron  
Brown aluminum

**FAPR988**  
Aluminium muscade\*  
Muscade aluminum

**FAPR971**  
Aluminium blanc  
White aluminum

1pc/1box 0,045 m<sup>3</sup>  
11 kg

**FAPR980**  
Aluminium gris espace  
Space grey aluminum

**FAPR969**  
Aluminium couleur Corten,  
Corten color aluminum

**FAPR999**  
Aluminium Marron  
Brown aluminum

**FAPR979**  
Aluminium muscade\*  
Muscade aluminum

**FAPR970**  
Aluminium blanc  
White aluminum

1pc/1box 0,032 m<sup>3</sup>  
10 kg

**XEPI380**  
Aluminium gris espace  
Space grey aluminum

**XEPI381**  
Aluminium blanc  
White aluminum

1pc/1box 0,07 m<sup>3</sup>  
14 kg

\* Uniquement en commande Pré-saison.  
Only on pre-seasonal order



FAPR			XEPI		FAPR			PLATEAUX POUR RÉF. FAPR ET XEPI380 / XEPI381 TOP TABLE FOR REF. FAPR AND XEPI380 / XEPI381							
60 x 60 CM 24" X 24"	70 x 70 CM 27" X 27"	80 x 80 CM 31" X 31"	110 x 70 CM 48" X 27"	120 x 80 CM 48" X 31"	Ø 80 CM Ø 31"	Ø 90 CM Ø 35"	Ø 100 CM Ø 39"	H306060	H307070	H308080	H311070	H312080	H300080	H300090	H300100
Poids : 5 kg Vol.: 0,033 m <sup>3</sup>	Poids : 7 kg Vol.: 0,044 m <sup>3</sup>	Poids : 9 kg Vol.: 0,056 m <sup>3</sup>	Poids : 11 kg Vol.: 0,069 m <sup>3</sup>	Poids : 14 kg Vol.: 0,085 m <sup>3</sup>	Poids : 9 kg Vol.: 0,056 m <sup>3</sup>	Poids : 11 kg Vol.: 0,071 m <sup>3</sup>	Poids : 14 kg Vol.: 0,087 m <sup>3</sup>								

**PLATEAU HPL ARDOISE**  
SLATE GREY HPL TOP TABLE

Colisages : 1pc/1box



**PLATEAU HPL CÉRAMIQUE GRISE**  
GREY CERAMIC HPL

Colisages : 1pc/1box



**PLATEAU HPL BÉTON CIRÉ**  
WHITE WASH CONCRETE HPL

Colisages : 1pc/1box

■ Références en stock - On Stock - Attention : seules certaines références sont stockées, vous reporter à celles identifiées comme telles. Autres références sur commande. nous consulter  
Warning : only few references are on stock. Others on special orders



# TEKURA

Design by Claude Robin

D'inspiration japonaise, la collection TEKURA offre un mélange de matière teck massif / HPL au rendu noble et chaleureux. Matière d'origine des JARDINS®, le teck massif est sublimé par les formes élégantes données aux pieds des tables et des canapés et par le mariage avec le HPL ardoise. Conçu pour l'extérieur cette collection trouvera également sa place à l'intérieur de la maison.

The harmonious blend of solid teak and slate grey HPL creates a stylish collection suitable for both indoor and outdoor environments.





Matières : Teck massif, HPL finition ardoise, toile, coussinage Sunbrella®

Entretien : Le teck est une matière « vivante ». Au fil de sa vie il va griser naturellement à cause du soleil, de la pluie et du temps qui passe. Nous conseillons de laisser votre teck vieillir naturellement, il prendra alors une teinte argentée qui n'altèrera aucunement sa qualité ou sa longévité. Nous conseillons de nettoyer le plateau des tables en HPL après chaque repas à l'eau savonneuse ou au nettoyant pour vitres. Enfin, les coussins sont déperlants mais doivent être hivernés.

Materials: Solid teak, slate grey HPL, sling, Sunbrella® cushions

Maintenance: The teak is a « living » material. During its life its color will slowly turn to a light silver grey. We recommend to let teak grey naturally without any treatment. Cushions are water repellent but need to be stored in winter. It is advisable to clean up the table HPL top after each meal.



CANAPÉ 3 PLACES TEKURA x 2/3  
AVEC PLATEFORME  
TEKURA 3 SEATS SOFA



Teck massif, HPL ardoise,  
Sunbrella® grafito  
Solid Teak, slate grey HPL,  
Grafito Sunbrella®



Teck massif, HPL ardoise,  
Sunbrella® gris clair  
Solid Teak, slate grey HPL,  
Light grey Sunbrella®



HOUSSE DE PROTECTION  
PROTECTION COVER  
HP03520



CANAPÉ 2 PLACES TEKURA x 2/3  
SANS PLATEFORME  
TEKURA 2 SEATS SOFA WITHOUT PLATFORM



Teck massif, HPL ardoise,  
Sunbrella® grafito  
Solid Teak, slate grey HPL,  
Grafito Sunbrella®



Teck massif, HPL ardoise,  
Sunbrella® gris clair  
Solid Teak, slate grey HPL,  
Light grey Sunbrella®



HOUSSE DE PROTECTION  
PROTECTION COVER  
HP03520



FAUTEUIL TEKURA  
TEKURA LOW ARMCHAIR



Teck massif, HPL ardoise,  
Sunbrella® grafito  
Solid Teak, slate grey HPL,  
Grafito Sunbrella®



Teck massif, HPL ardoise,  
Sunbrella® gris clair  
Solid Teak, slate grey HPL,  
Light grey Sunbrella®

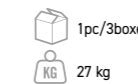

HOUSSE DE PROTECTION  
PROTECTION COVER  
HP03521



BASE POUF OU TABLE BASSE HPL TEKURA  
TEKURA HPL OTTOMAN BASE OR LOW TABLE



Teck massif, HPL ardoise  
Solid Teak, slate grey HPL

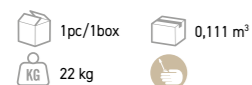

COUSSIN POUR POUF TISSU SUNBRELLA® TEKURA  
CUSHION FOR OTTOMAN BASE TEKURA IN SUNBRELLA® FABRIC



Sunbrella® grafito  
Grafito Sunbrella®



Sunbrella® gris clair  
Light grey Sunbrella®



FAUTEUIL BAS EMPILABLE TEKURA  
TEKURA STACKABLE LOW ARMCHAIR



Teck massif, toile ardoise  
Solid Teak, slate grey canvas

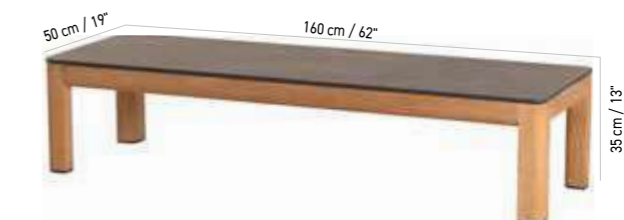
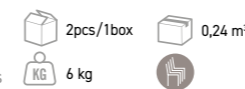
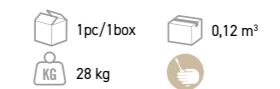

TABLE BASSE HPL TEKURA  
TEKURA HPL LOW TABLE



Teck massif, HPL ardoise  
Solid Teak, slate grey HPL



# TEKURA

TABLE, FAUTEUIL, CHAISE ET BANC  
TABLE, ARMCHAIR, CHAIR AND BENCH



TABLE EXTENSIBLE HPL AVEC ALLONGE PAPILLON TEKURA x 8/10  
TEKURA HPL EXTENDING TABLE WITH BUTERFLY EXTENSION

**TA02310\***

Teck massif, HPL ardoise  
Solid Teak, slate grey HPL

1pc/1box 0,495 m<sup>3</sup>  
57 kg



FAUTEUIL EMPILABLE TEKURA  
TEKURA STACKABLE ARMCHAIR

**FA02307A\***

Teck massif, toile ardoise  
Solid teak, slate grey canvas

2pcs/1box 0,22 m<sup>3</sup>  
5,5 kg



TABLE BISTRO HPL TEKURA x 2  
TEKURA HPL ISTRO TABLE

**TA02286\***

Teck massif, HPL ardoise  
Solid Teak, slate grey HPL

1pc/1box 0,07 m<sup>3</sup>  
18,5 kg



CHAISE PLIANTE TEKURA  
TEKURA FOLDING CHAIR

**PCH0953\***

Teck massif, toile ardoise  
Solid teak, slate grey canvas

2pcs/1box 0,07 m<sup>3</sup>  
4,75 kg

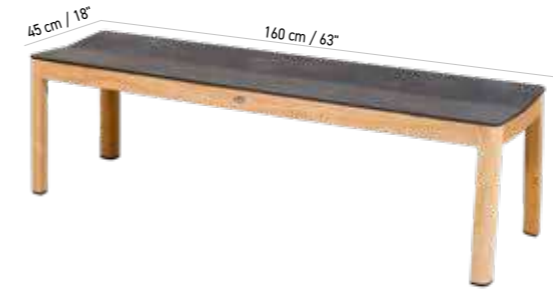

BANC DE TABLE HPL TEKURA AVEC ASSISE EN LATTES LARGES  
TEKURA HPL BENCH LARGE SLATS

**BA02302\***

Teck massif, HPL ardoise  
Solid Teak, slate grey HPL

1pc/1box 0,072 m<sup>3</sup>  
17,5 kg



BANC DE TABLE HPL TEKURA AVEC ASSISE EN LATTES LARGES  
TEKURA HPL BENCH LARGE SLATS

**BA02301\***

Teck massif, HPL ardoise  
Solid Teak, slate grey HPL

1pc/1box 0,051 m<sup>3</sup>  
10,5 kg



TABLE EXTENSIBLE HPL AVEC ALLONGE PAPILLON TEKURA x 6  
TEKURA HPL EXTENDING TABLE WITH BUTERFLY EXTENSION

**TA02319\***

Teck massif, HPL ardoise  
Solid Teak, slate grey HPL

1pc/1box 0,415 m<sup>3</sup>  
46 kg



TABLE TEKURA HPL x 6  
TEKURA HPL TABLE

**TA02280\***

Teck massif, HPL ardoise  
Solid Teak, slate grey HPL

1pc/1box 0,31 m<sup>3</sup>  
41 kg

TABOURET DE BAR TEKURA  
TEKURA BAR STOOL

**TB01200A\***

Teck massif, toile ardoise  
Solid teak, slate grey canvas

1pc/1box 0,33 m<sup>3</sup>  
10 kg



CHAISE PLIANTE PERGOLATEK  
PERGOLATEK FOLDING CHAIR

**CH12200\***

Teck massif  
Solid teak

2pcs/1box 0,076 m<sup>3</sup>  
7,5 kg



\* Ces produits sont disponibles sur commande. These products are available to order.

\* Ces produits sont disponibles sur commande. These products are available to order.



**BAIN DE SOLEIL EMPILABLE VALTECK**  
STRUCTURE ET LATTES EN TECK MASSIF  
VALTECK STACKABLE LOUNGER

**TRV9000**

Teck massif  
Solid teak

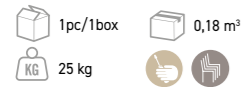

**BAIN DE SOLEIL EMPILABLE VALTECK**  
ROUES ARRIÈRES, TABLETTE ESCAMOTABLE  
VALTECK STACKING LOUNGER, BACKWHEEL, REMOVABLE SIDE SHELF

**TRV9005A**

Teck massif, toile ardoise  
Solid teak, slate grey canvas

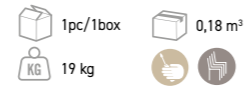

**TRV9006A**

Teck massif, toile taupe  
Solid teak, taupe canvas



**BAIN DE SOLEIL ARTICULÉ AZUR**  
AZUR CHAISE LOUNGE

**CTTR610\***

Teck massif  
Solid teak

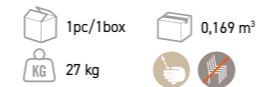

**KIT ACCOUDOIRS AZUR**  
AZUR ARMREST KIT

**CTTR631\***

Teck massif  
Solid teak

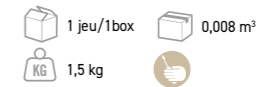

**CHILIENNE MARINA**  
MARINA DECK CHAIR

**CTTR621-P1\***

Teck massif, toile Batyline écru  
Solid teak, off white Batyline canvas

**CTTR621-P2\***

Teck massif, toile Batyline cendre  
Solid teak, ash grey Batyline canvas



**CTTR621-P3\***

Teck massif, toile Batyline Eden blanc chiné  
Solid teak, White grey Batyline Eden canvas

**CTTR621-P4\***

Teck massif, toile tissée grafito  
Solid teak, slate grey canvas



**TABLE BASSE TEKURA HPL**  
TEKURA HPL LOW TABLE

**TA02318\***

Teck massif, HPL ardoise  
Solid Teak, slate grey HPL



**TABLE BASSE CARRÉE CROISSILLON**  
CRISS CROSS TABLE

**CTTA410\***

Teck massif  
Solid teak

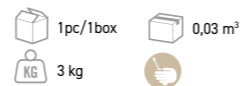

**COUSSIN BAIN DE SOLEIL ARTICULÉ AZUR**  
AZUR LOUNGER CUSHION

**CE00306\*** **CL00306\***

Ecru  
Off white

Lombok  
Taupe

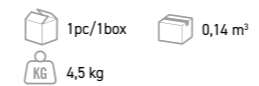

**COUSSIN SPUNPOLY**  
SPUNPOLY CUSHION

**CST9001**

Spunpoly taupe  
Taupe spunpoly

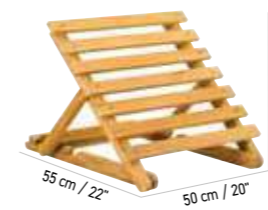
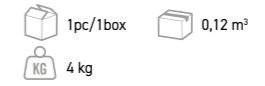

**TÊTIÈRE DE PLAGE RÉGLABLE**  
AJUSTABLE BEACH HEAD REST

**TR05032\***

Teck massif  
Solid teak

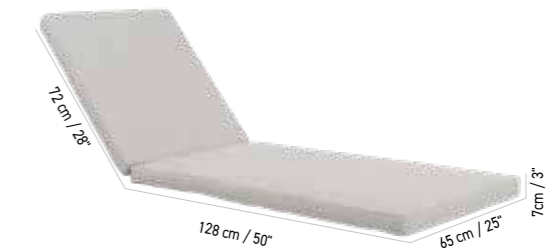
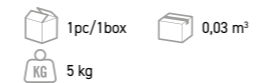

**COUSSIN VALTECK**  
VALTECK CUSHION

**C006162**

Ateja gris clair  
Light grey Ateja



\* Ces produits sont disponibles sur commande. These products are available to order.

\* Ces produits sont disponibles sur commande. These products are available to order.

# RIOSQUES



## LIT BALINAIS ZAYO

Structure aluminium et teck massif. Mâts wicker brossé couleur chanvre. Livré avec deux matelas et six coussins (tissu Sunbrella®). Mousse (polyuréthane) densité 30kg + 1 cm molleton (fibre polyester) dans housse TNT (Tissu non tissé) en fibre polypropylène. Dossiers et repose pieds inclinables individuellement.

BALINESE DAY BED. Structure aluminum and solid teak. Poles aluminum and brushed wicker. Delivered with 2 mattresses and 4 cushions (Sunbrella® fabrics). Backrests and footrests individually removable.



DBGW501

Aluminium et teck massif, wicker brossé couleur chanvre, tissu Sunbrella®  
Structure aluminum and solid teak, brushed wicker, Sunbrella®

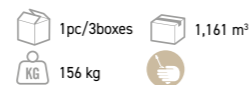

STRUCTURE FRAME			CM
L	L	H	
222	162	249	INCH
86,6	63	97	

TOILE CANOPY		CM
D	H	
302	216	INCH
118	84	



Retrouvez le produit page 67  
Find the product page 67



Retrouvez le produit page 79  
Find the product page 79



LIT BALINAIS TOIT PLAT COULISSANT en Sunbrella® taupe - Structure aluminium et teck massif. Mâts wicker brossé couleur chanvre. Livré avec deux matelas et six coussins (tissu Sunbrella®). Mousse (polyuréthane) densité 30kg + 1 cm molleton (fibre polyester) dans housse TNT (Tissu non tissé) en fibre polypropylène. Dossiers et repose pieds inclinables individuellement

BALINESE DAY BED WITH REMOVABLE ROOF. Structure aluminum and solid teak. Poles in aluminum and brushed all weather wicker. Delivered with 2 mattresses and 6 cushions in Sunbrella® fabric. Backrests and footrests individually removable.

UNIQUEMENT SUR COMMANDE SPÉCIALE



DBGW502

Aluminium et teck massif, wicker brossé couleur chanvre, tissu Sunbrella®  
Structure aluminum and solid teak, brushed wicker, Sunbrella®



STRUCTURE FRAME			CM
L	L	H	
222	162	249	INCH
86,6	63	97	

# DOUCHES



STRUCTURE DOUCHE SOLAIRE DROITE ODALO  
AVEC CAILLEBOTTIS SANS ROBINETTERIE\*  
SOLAR SHOWER FRAME IN TEAK WITH DUCK BOARD

P	L	H
80	16	223
31	6	87

**SDS2010**

Teck massif  
Solid teak

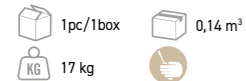

\* A COMMANDER AVEC KSD2003

KIT SOLAIRE AVEC ROBINETTERIE POUR REF SDS2010  
SOLAR AND PLUMBING KIT FOR REF SDS2010

**KSD2003**

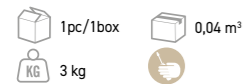

STRUCTURE DOUCHE SOLAIRE COURBE ODALO  
AVEC SOCLE, SANS ROBINETTERIE\*  
STRUCTURE ODALO SHOWER WITH DECK

P	L	H
120	81	218
47	32	86

**SDS2006**

Teck massif  
Solid teak



\* A COMMANDER AVEC KSD2002

KIT SOLAIRE AVEC ROBINETTERIE POUR REF SDS2006  
SOLAR AND PLUMBING KIT FOR REF SDS2006

**KSD2002**

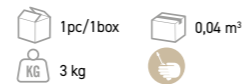

STRUCTURE DOUCHE SOLAIRE DROITE ODALO  
AVEC CAILLEBOTTIS TECK MASSIF EN DURATEK® SANS ROBINETTERIE\*  
ODALO SOLAR SHOWER FRAME IN SOLID TEAK DURATEK®

P	L	H
65	55	222
25,6	21,6	87,4

**SDS2011**

Teck massif à la finition Duratek®  
Duratek® finish solid teak\*



\* A COMMANDER AVEC KSD2003

KIT SOLAIRE AVEC ROBINETTERIE POUR REF SDS2011  
SOLAR AND PLUMBING KIT FOR REF SDS2011

**KSD2003**



# PARASOLS

CONFIGURABLES / EXCENTRÉS  
CLASSIQUES / GRAND FORMAT



PTA3200



PAA3030

Cœur de métier de la marque LES JARDINS®, nous attachons une grande importance à nos parasols. En teck massif ou en aluminium et dans un grand choix de dimensions, chaque pièce est interchangeable pour garantir une longévité optimale.

Matières : Aluminium, Teck massif, Toile Olefin, Toile Sunbrella®

Entretien : Ne jamais laisser un parasol ouvert lorsque le vent est fort. Mettre la housse de protection lorsque le parasol est inutilisé.

Our umbrellas : solid teak or aluminum, conventional or cantilever, are manufactured to perfection. They are built to last, that is why we made sure that each sensitive part is easily replaceable.

Materials: Aluminum, Solid teak, Olefin canopy, Sunbrella® canopy

Maintenance: Never leave an umbrella open in windy conditions. Use the protective cover when the umbrella is closed for a long period of time.

# LES CONFIGURABLES / THE CONFIGURABLES

## ARMATURES / RIBS FRAME

ALUMINIUM  
ALUMINIUM



ARMATURE PARASOL ALU  
Ø 2,1M Ø 38 MM H : 230 CM + HOUSSE  
6 RIBS FRAME FOR 7' ALU UMBRELLA,  
ANODIZED POLE 1 1/2 POLE H: 92"  
BLACK PAA2100 WHITE PAB2100

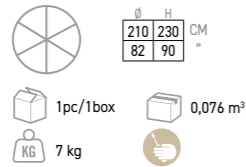

ARMATURE PARASOL ALU  
Ø 3,2 M Ø 48 MM H 265 CM + HOUSSE  
8 RIBS FRAME FOR 10' ROUND  
ALU UMBRELLA, ANODIZED  
POLE 1 3/4 POLE H: 108"  
BLACK PAA3200 WHITE PAB3200

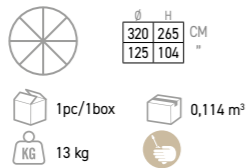

ARMATURE PARASOL ALU  
2,1M X 2,1M Ø 48 MM H 265 CM + HOUSSE  
8 RIBS FRAME FOR 7' X 7' ALU UMBRELLA,  
ANODIZED POLE 1 3/4 POLE - H: 92"  
BLACK PAA2121 WHITE PAB2121

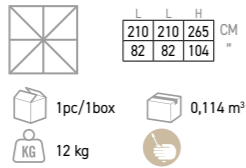

ARMATURE PARASOL ALU  
3 M X 3 M Ø 58 MM H 265 CM, + HOUSSE  
8 RIBS FRAME FOR 10' X 10' ALU UMBRELLA,  
ANODIZED POLE 2 1/4 POLE  
BLACK PAA3030 WHITE PAB3030

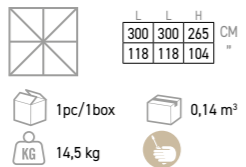

ARMATURE PARASOL ALU  
2 M X 3 M Ø 48 MM H 265 CM + HOUSSE  
6 RIBS FRAME FOR 6'7" X 10'  
ALU UMBRELLA, ANODIZED  
POLE 1 3/4 POLE - H : 104"  
BLACK PAA2030 WHITE PAB2030

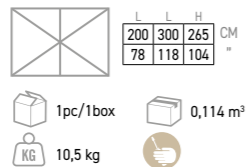

ARMATURE PARASOL ALU  
3 M X 4 M Ø 58 MM H 275 CM + HOUSSE  
8 RIBS FRAME FOR 10' X 13' ALU UMBRELLA,  
ANODIZED POLE 2 1/4 POLE  
BLACK PAA3040 WHITE PAB3040

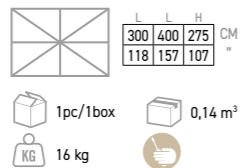

TECK MASSIF  
SOLID TEAK



ARMATURE PARASOL TECK MASSIF  
Ø 2,1M H 250 CM Ø 38 MM + HOUSSE  
6 RIBS UMBRELLA FRAME FOR 6'7" X 10'  
SOLID TEAK UMBRELLA, POLE 1 1/2 POLE  
PTA2100

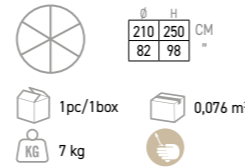

ARMATURE PARASOL TECK MASSIF  
Ø 3,2 M, H 265 CM, Ø 48 MM + HOUSSE  
8 RIBS FRAME FOR 10' ROUND  
SOLID TEAK UMBRELLA, POLE 1 3/4 POLE + COVER  
PTA3200

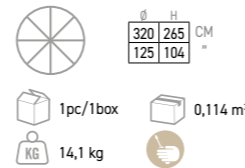

ARMATURE PARASOL TECK MASSIF  
2,1 X 2,1M, Ø 48 MM + HOUSSE  
8 RIBS FRAME FOR 7' X 7' SOLID TEAK UMBRELLA,  
POLE 1 3/4 POLE + COVER  
PTA2121

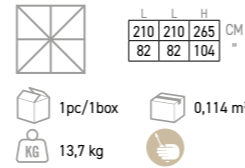

ARMATURE PARASOL TECK MASSIF  
3 X 3 M, Ø 58 MM + HOUSSE  
8 RIBS FRAME FOR 10' X 10'  
SOLID TEAK UMBRELLA, POLE 2 1/4 POLE  
PTA3030

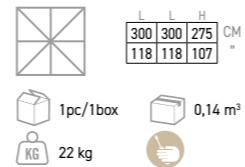

ARMATURE PARASOL TECK MASSIF  
2 X 3 M, Ø 48 MM + HOUSSE  
6 RIBS FRAME FOR 6'7" X 10'  
SOLID TEAK UMBRELLA, POLE 1 3/4 POLE  
PTA2030

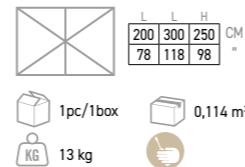

ARMATURE PARASOL TECK MASSIF  
3 X 4 M, Ø 58 MM + HOUSSE  
8 RIBS FRAME FOR 10' X 13'  
SOLID TEAK UMBRELLA, POLE 2 1/4 POLE  
PTA3040

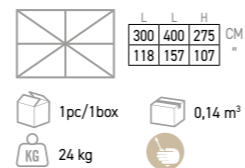

# LES CONFIGURABLES / THE CONFIGURABLES

## TOILES / CANOPIES

(COMMUNS AUX PARASOLS ALUMINIUM ET TECK MASSIF)  
(CANOPIES FOR ALUMINIUM AND SOLID TEAK UMBRELLAS)

TOILE OLEFIN 220 g/m<sup>2</sup>  
POUR PAA2100 ET PTA2100  
POLYPROPYLEN OLEFIN CANOPY  
FOR PAA2100 AND PTA2100



TOE2100 Ecru - Off white  
TOT2100 Taupe - Taupe  
TON2100 Anthracite - Black  
TOG2100 Gris - Grey  
TOB2100 Blanc - White

TOILE OLEFIN 220 g/m<sup>2</sup>  
POUR PAA3200 ET PTA3200  
POLYPROPYLEN OLEFIN CANOPY  
FOR PAA3200 AND PTA3200



TOE3200 Ecru - Off white  
TOT3200 Taupe - Taupe  
TON3200 Anthracite - Black  
TOG3200 Gris - Grey  
TOB3200 Blanc - White

TOILE OLEFIN 220 g/m<sup>2</sup>  
POUR PAA2121 ET PTA2121  
POLYPROPYLEN OLEFIN CANOPY  
FOR PAA2121 AND PTA2121



TOE2121 Ecru - Off white  
TOT2121 Taupe - Taupe  
TON2121 Anthracite - Black  
TOG2121 Gris - Grey  
TOB2121 Blanc - White

TOILE OLEFIN 220 g/m<sup>2</sup>  
POUR PAA3030 ET PTA3030  
POLYPROPYLEN OLEFIN CANOPY  
FOR PAA3030 AND PTA3030



TOE3030 Ecru - Off white  
TOT3030 Taupe - Taupe  
TON3030 Anthracite - Black  
TOG3030 Gris - Grey  
TOB3030 Blanc - White

TOILE OLEFIN 220 g/m<sup>2</sup>  
POUR PAA2030 ET PTA2030  
POLYPROPYLEN OLEFIN CANOPY  
FOR PAA2030 AND PTA2030



TOE2030 Ecru - Off white  
TOT2030 Taupe - Taupe  
TON2030 Anthracite - Black  
TOG2030 Gris - Grey  
TOB2030 Blanc - White

TOILE OLEFIN 220 g/m<sup>2</sup>  
POUR PAA3040 ET PTA3040  
POLYPROPYLEN OLEFIN CANOPY  
FOR PAA3040 AND PTA3040

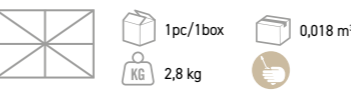

TOE3040 Ecru - Off white  
TOT3040 Taupe - Taupe  
TON3040 Anthracite - Black  
TOG3040 Gris - Grey  
TOB3040 Blanc - White

## SOCLES / BASES

(COMMUNS AUX PARASOLS ALUMINIUM ET TECK MASSIF)  
(FOR ALUMINIUM AND SOLID TEAK UMBRELLAS)

SOCLE PARASOL 42X42 POUR Ø 38 MM  
UMBRELLA BASE 17" X 17" FOR 1 1/2 POLE



SA00138 Noir - Black  
SA00238 Blanc - White

SOCLE PARASOL 56X56 POUR Ø 48 MM  
UMBRELLA BASE 21" X 21" FOR 1 3/4 POLE



SA00148 Noir - Black  
SA00248 Blanc - White

SOCLE PARASOL 68X68 POUR Ø 58 MM  
UMBRELLA BASE 26" X 26" FOR 2 1/4 POLE



SA00158 Noir - Black  
SA00258 Blanc - White

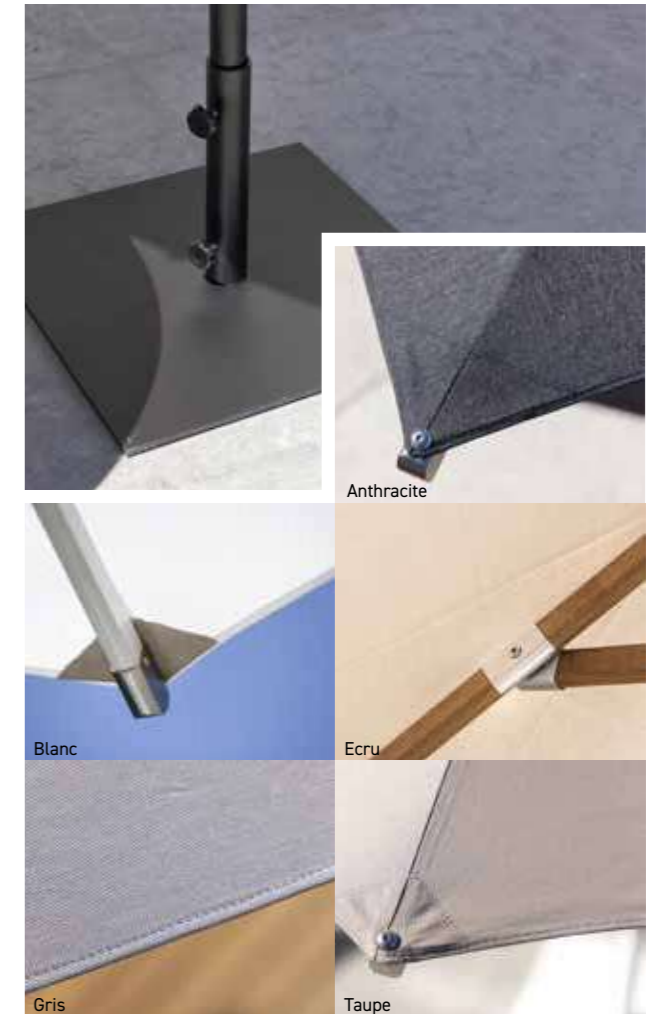

## PARASOLS EXCENTRÉS / OFF-CENTRES UMBRELLAS

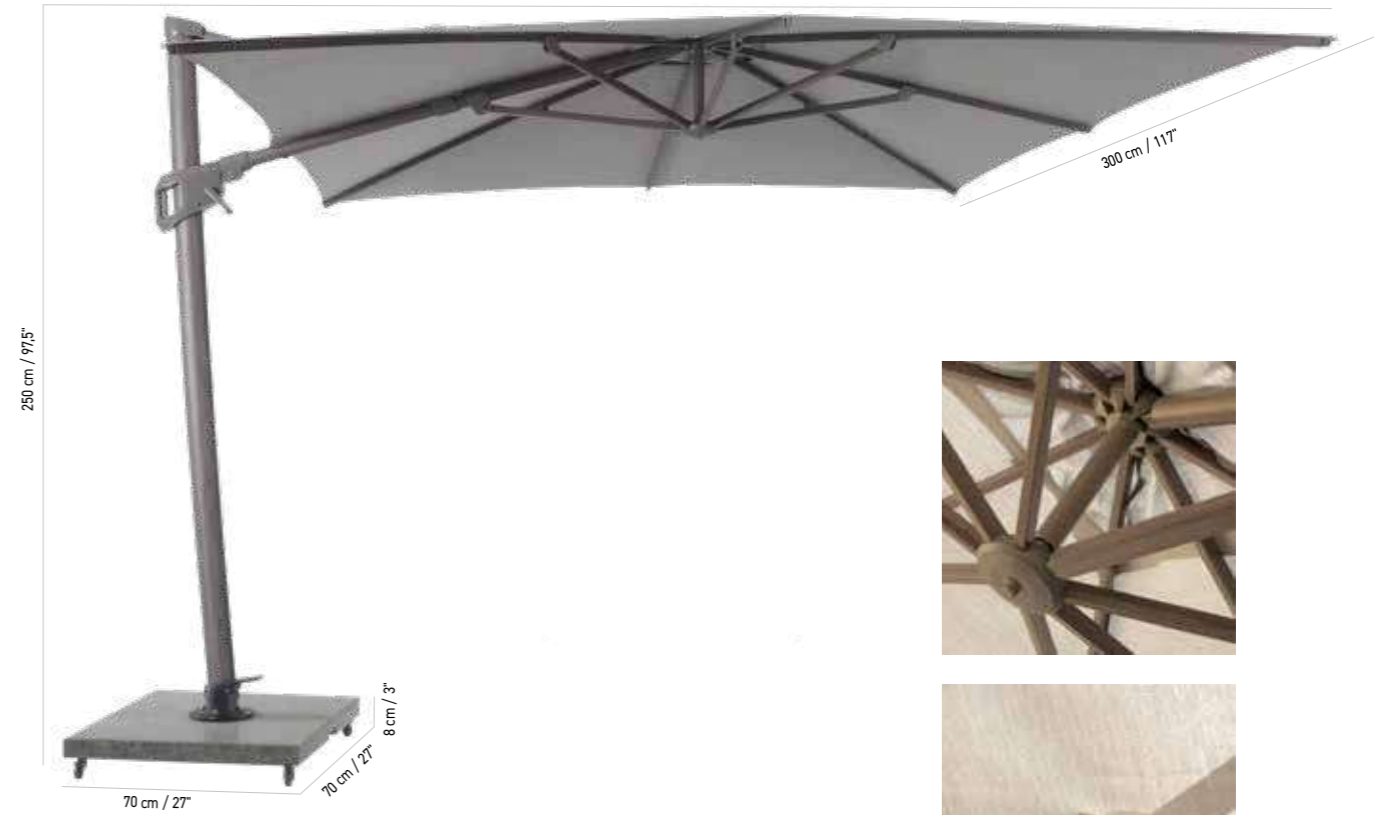

PARASOL EXCENTRÉ 3X3, SOCLE EN GRANITE AVEC ROULETTES INOX  
 + HOUSSE DE PROTECTION SKAAL  
 SKAAL HANGING UMBRELLA WITH GRANIT BASE, INOX WHEELS  
 + PROTECTION COVER



PES3030/P1

Aluminium effet Duratek®  
 Sunbrella® natté gris clair 275g/m²,  
 socle granite  
 Duratek®\*\* aluminum, grey Sunbrella®,  
 plinth granit

1pc/3boxes 0,437 m³  
 136 kg



# PARASOLS EXCENTRÉS / OFF-CENTRES UMBRELLAS

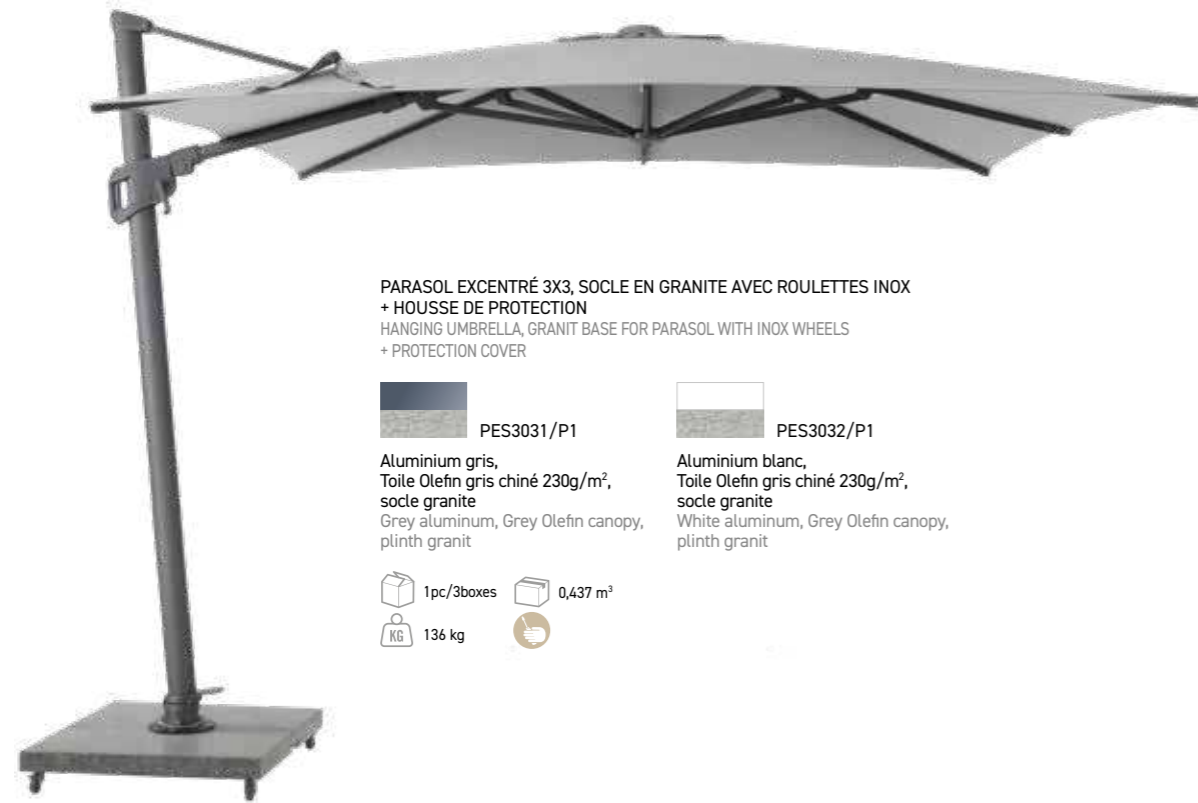
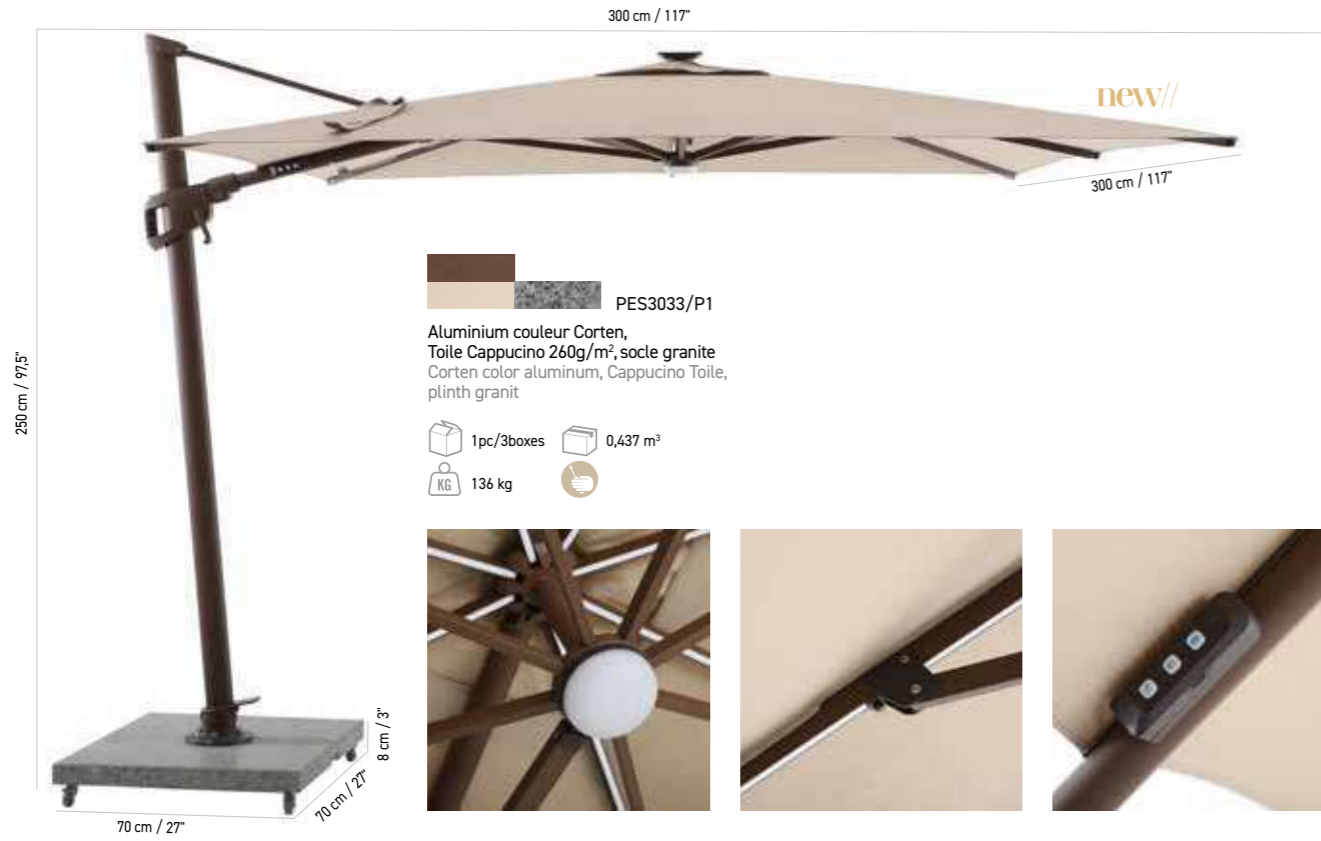

PARASOL EXCENTRÉ 3X3, AVEC SYSTÈME SOLAIRE LED + SOCLE EN GRANITE AVEC ROULETTES INOX  
 + HOUSSE DE PROTECTION  
 HANGING UMBRELLA WITH SOLAR SYSTEM + GRANIT BASE, INOX WHEELS + PROTECTION COVER







PARASOLS CLASSIQUES / CLASSICS UMBRELLAS







**PARASOL 3X3 M MAT Ø,48 MM, OUVERTURE SYSTÈME DE POULIE** **new//**    
 + HOUSSE DE PROTECTION SKAAL  
 SKAAL HANGING UMBRELLA ANODIZED POLE 1"88, OPENING PULLEY SYSTEM  
 + PROTECTION COVER

- |  |  |
|--|--|
|  <b>PMC3030</b> |  <b>PDC3030</b> |
| Aluminium Duratek®,<br>Toile gris clair 260g/m²<br>Duratek® aluminum,<br>Light grey canvas         | Aluminium couleur Corten,<br>Toile Cappucino 260g/m²<br>Corten color aluminum,<br>Cappucino canvas |



 1pc/1box  0,123 m³  
 14 kg 



**SOCLE POUR PARASOL**  
 BASE FOR PARASOL





- |  |  |
|--|--|
|  <b>BSPN048</b> |  <b>BSPC048</b> |
| Acier noir<br>Black steel  | Acier couleur Corten<br>Corten color steel   |

 1pc/1box  0,024 m³  
 48 kg 





**PARASOL 2,1X2,1 M MAT CARRÉ 38X38 MM, OUVERTURE PUSH UP** **new//**    
 + HOUSSE DE PROTECTION SKAAL  
 SKAAL HANGING UMBRELLA STRAIGHT POLE SIZE: 38X38MM, PUSH OPEN  
 + PROTECTION COVER

- |  |  |
|--|--|
|  <b>PDS2121</b> |  <b>PDC2121</b> |
| Aluminium Duratek®,<br>Toile gris clair 260g/m²<br>Duratek® aluminum,<br>Light grey canvas           | Aluminium couleur Corten,<br>Toile Cappucino 260g/m²<br>Corten color aluminum,<br>Cappucino canvas   |

 1pc/1box  0,060 m³  
 5 kg 

**SOCLE POUR PARASOL**  
 BASE FOR PARASOL

- |  |  |
|--|--|
|  <b>BSPN020</b> |  <b>BSPC020</b> |
| Acier noir<br>Black steel  | Acier couleur Corten<br>Corten color steel   |

 1pc/1box  0,024 m³  
 20 kg 





Conçue pour répondre aux exigences des hôtels, restaurants et espaces extérieurs à usage professionnel, la gamme TITAN PRO allie performance, durabilité et design contemporain.

Son mât central profilé en aluminium structuré (Ø100 mm, épaisseur 3,3 mm) et sa visserie inox de haute qualité garantissent une excellente résistance à la corrosion et facilitent le remplacement de la toile ou des pièces détachées pour une maintenance simplifiée et une longévité optimale.

Le système télescopique à manivelle permet une ouverture et fermeture aisées, sans avoir à déplacer le mobilier environnant. Grâce à une résistance au vent supérieure à 70 km/h, le parasol TITAN PRO assure une stabilité remarquable, même dans des conditions exigeantes.

Innovant, ce modèle intègre désormais un éclairage LED solaire discret et élégant, placé le long des baleines. Ce système lumineux et autonome crée une ambiance chaleureuse à la tombée de la nuit, tout en réduisant la consommation électrique.

**Caractéristiques principales :**

**Armature :** mât central en aluminium structuré et nervuré Ø100 mm, ép. 3,3 mm. **Baleines :** 8 unités, dim. 20x38 mm, ép. 2 mm. **Ouverture/Fermeture :** manivelle avec système télescopique. **Résistance au vent :** > 70 km/h. **Éclairage :** LED solaires intégrées sur les baleines, recharge automatique par capteurs solaires. **Usage :** professionnel – hôtels, restaurants, terrasses et espaces extérieurs haut de gamme.

Designed to meet the demands of hotels, restaurants, and professional outdoor spaces, the TITAN PRO range combines performance, durability, and contemporary design.

Its central, profiled, structured aluminum pole (D3.93", 0.13" thick) and high-quality stainless steel screws guarantee excellent corrosion resistance and facilitate the replacement of the canopy or spare parts for simplified maintenance and optimal longevity.

The telescopic crank system allows for easy opening and closing without having to move surrounding furniture. With a wind resistance of over 70 km/h, the TITAN PRO parasol ensures remarkable stability, even in demanding conditions.

This innovative model now incorporates discreet and elegant solar-powered LED lighting, positioned along the ribs. This self-contained lighting system creates a warm ambiance at nightfall while reducing electricity consumption.

**Main Features:**

**Frame:** Central pole in structured and ribbed aluminum, D3.93", 0.13" thick. **Ribs:** 8 units, 0.78"x1.49", 0.07" thick. **Opening/Closing:** Crank with telescopic system; **Wind resistance:** > 70 km/h. **Lighting:** Solar LEDs integrated into the ribs, automatically recharged by solar panels. **Use:** Professional – hotels, restaurants, terraces, and high-end outdoor spaces.

PARASOL TITAN PRO / PRO TITAN UMBRELLA



PARASOL ÉCLAIRAGE SOLAIRE 5X5, À LED INTÉGRÉES  
+ HOUSSE DE PROTECTION  
SOLAR-POWERED UMBRELLA WITH INTEGRATED LEDS  
+ PROTECTION COVER

new//

260g/m²



PT15050

Anodisation mat 2S,  
Toile gris clair 260g/m²  
Matt anodizing 2S,  
Light grey canva

1pc/1box 0,356 m³  
50 kg

ANCRAGE DU PARASOL  
UMBRELLA ANCHORING



ANCRE DE FIXATION  
FIXING ANCHOR

AFI5050  
Acier zingué  
hot galvanized

1pc/1box  
5 kg  
0,021 m³



PLATINE FIXATION M4  
M4 MOUNTING PLATE

PFI5050  
Acier galvanisé  
hot galvanized

1pc/1box  
2 kg  
0,003 m³

BASE DU PARASOL  
UMBRELLA BASE



BASE PARASOL TITAN AVEC CACHE  
ALUMINIUM ET PIEDS RÉGLABLES  
TITAN PARASOL BASE WITH ALUMINIUM  
COVER AND ADJUSTABLE FEET

BAG5050  
Acier galvanisé  
hot galvanized

1pc/1box  
15 kg  
0,216 m³

DALLE GRANITE LESTÉE  
AVEC POIGNÉE  
WEIGHTED GRANIT SLAB  
WITH HANDLE

DGT5050  
Socle granite  
Granit plinth

1pc/1box  
15 kg  
0,026 m³



# COFFRES



COFFRE TECK MASSIF FINITION DURATEK® SKAAL  
SKAAL CUSHION BOX IN SOLID TEAK WITH DURATEK® TREATMENT FINISHING

**CO02017**  
Teck massif à la finition Duratek®  
Duratek® finish solid teak

1pc/1box 0,99 m<sup>3</sup>  
57 kg



COFFRE SAQQARAH 130 CM  
SAQQARAH CUSHION BOX

**CO02002\***  
Teck massif  
Solid teak

1pc/1box 0,546 m<sup>3</sup>  
29 kg



COFFRE SAQQARAH 155 CM  
SAQQARAH CUSHION BOX

**CO02006\***  
Teck massif  
Solid teak

1pc/1box 0,969 m<sup>3</sup>  
59 kg

\* Ces produits sont disponibles sur commande. These products are available to order.

# TAPIS NATUREL BEIGE / DORÉ NATURAL BEIGE GOLD CARPET

Cette saison LES JARDINS® édite un tapis en matière recyclée. Intemporel, il vient habiller tous vos espaces extérieurs petits ou grands.

This season LES JARDINS® is releasing a rug in recycled material. Timeless, it comes to dress all your outdoor spaces, big or small.

Autres formats disponibles sur demande.  
Other sizes available on demand.

Tapis durables pour l'extérieur : fabriqués à partir de bouteilles en plastique recyclées.  
Les bouteilles en plastique PET recyclées constituent les principales matières premières de notre gamme de tapis :  
- Convient pour un usage intérieur/extérieur : Nos tapis sont fabriqués à partir de fils résistants à l'eau et conformes aux tests de résistance aux UV et à l'abrasion afin de garantir des performances optimales en toutes saisons.  
- Nettoyage facile : Fabriqué avec un fil de PET recyclé de haute technologie, il est très facile à entretenir. Il ne nécessite pas de nettoyage spécialisé. De l'eau de javel peut être utilisée pour les tâches les plus difficiles.

Recycled PET plastic bottles are the main raw materials for our carpet range:  
- Suitable for indoor/outdoor use: Our carpets are made from water resistant yarns that are UV and abrasion tested to ensure optimum performance in all seasons.  
- Easy to clean: Made from high-tech recycled PET yarn, it is very easy to maintain. It does not require specialized cleaning. Bleach can be used for the most difficult.

TAPIS BEIGE/DORE GOLDEN BEIGE CARPET

400 x 400 cm / 157,5" x 157,5"	1pc/1box	36 kg	0,16 m <sup>3</sup>
TAP0002			
400 x 300 cm / 57,5" x 118,11"	1pc/1box	27 kg	0,12 m <sup>3</sup>
TAP0003			
200 x 300 cm / 78,74" x 118,11"	1pc/1box	13 kg	0,08 m <sup>3</sup>
TAP0004			



# HOUSES DE PROTECTION POUR FAUTEUIL ET CANAPÉ PROTECTION COVERS ARMCHAIR AND SOFA

## Collection Rancho

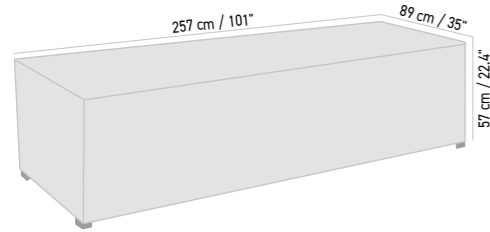

HOUSSE DE PROTECTION x 3/4  
PROTECTION COVER  
HP03550

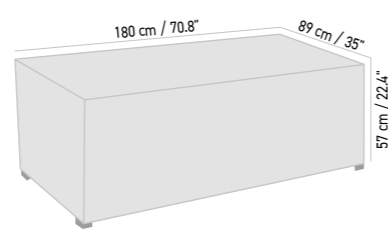

HOUSSE DE PROTECTION x 2/3  
PROTECTION COVER  
HP03551

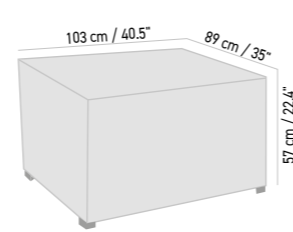

HOUSSE DE PROTECTION FAUTEUIL  
PROTECTION COVER ARMCHAIR  
HP03552

## Collection Skaal (small)

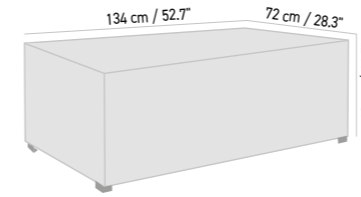

HOUSSE DE PROTECTION x 2/3  
PROTECTION COVER  
HP03532

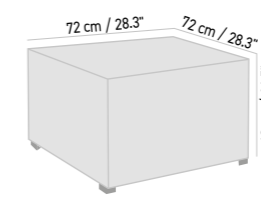

HOUSSE DE PROTECTION FAUTEUIL  
PROTECTION COVER ARMCHAIR  
HP03536

## Collections Copenhague / Skaal / Bastingage

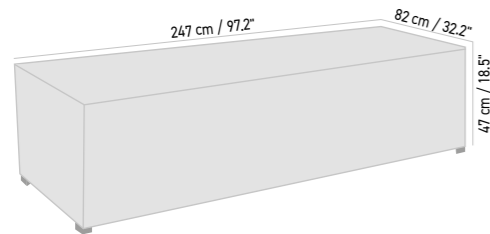

HOUSSE DE PROTECTION x 3/4  
PROTECTION COVER  
HP03530

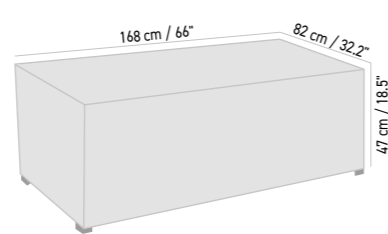

HOUSSE DE PROTECTION x 2/3  
PROTECTION COVER  
HP03531

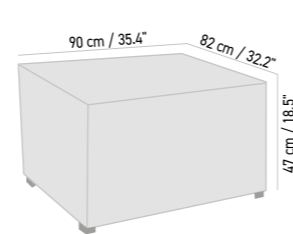

HOUSSE DE PROTECTION FAUTEUIL  
PROTECTION COVER ARMCHAIR  
HP03535

## Collection Tekura

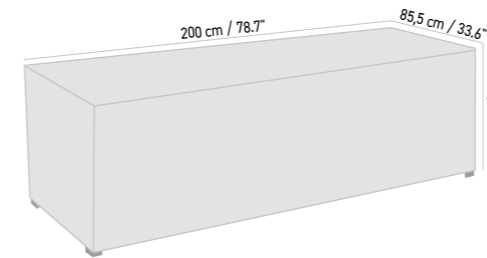

HOUSSE DE PROTECTION x 3/4  
PROTECTION COVER  
HP03520

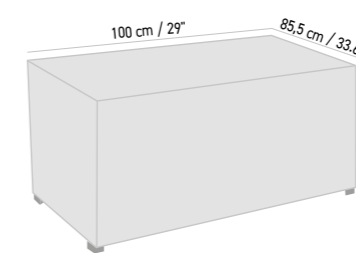

HOUSSE DE PROTECTION x 2/3  
PROTECTION COVER  
HP03521

## Collection Chester

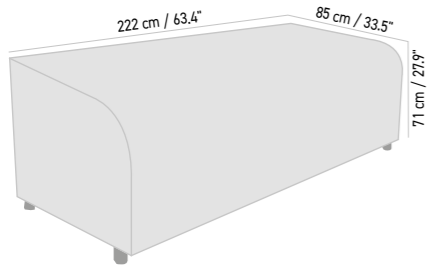

HOUSSE DE PROTECTION x 3/4  
PROTECTION COVER  
HP05501

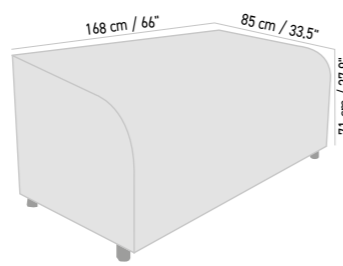

HOUSSE DE PROTECTION x 2/3  
PROTECTION COVER  
HP05500

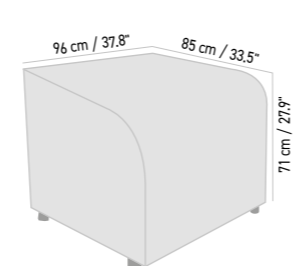

HOUSSE DE PROTECTION FAUTEUIL  
PROTECTION COVER ARMCHAIR  
HP05502

## ENTRETIEN & PROTECTION / CLEANING & PROTECTION

### TECK

NETTOYANT  
DÉGRISSEUR  
POUR TECK  
SPRAY 1 L  
NETDFP6

Colisage : 6pcs/1box  
Poids : 0,8 kg



### INOX

POLISH POUR  
CHROME  
ET INOX  
0,237 L  
NETO8NP

Colisage : 6pcs/1box  
Poids : 0,4 kg



### HPL KIT

NETTOYANT HPL  
DEGRAISSANT  
HYPERACTIF  
750 ML  
NETHPL1



+

RAVIVEUR  
PROTECTEUR  
HPL  
250 ML  
RAVHPL2



## Le choix des bonnes matières

Chez **Les Jardins®**, nos engagements sont simples : proposer des produits bien pensés, fabriqués avec soin et issus de pratiques responsables.

### The right choice of materials

At **Les Jardins®**, our commitments are simple: to offer thoughtfully designed products, crafted with care, and made through responsible practices.

## Design et responsabilité

Le **teck** est au cœur de nombreuses collections **Les Jardins®**. Même s'il ne pousse pas en France, nous veillons à ce que son origine soit contrôlée et respectueuse :

- Le teck que nous utilisons provient exclusivement d'**Indonésie**, issu de **plantations certifiées et gérées de façon raisonnée**.
- Nous choisissons, chaque fois que possible, des **fournisseurs français ou européens** afin de limiter les transports et de soutenir les savoir-faire locaux.
- Nous demandons à l'ensemble de nos partenaires de garantir des **conditions de travail sûres et équitables**, au-delà des normes en vigueur.

Ces principes guident nos choix et nous encouragent à progresser chaque jour.

### Design and responsibility

Teak is at the heart of many **Les Jardins®** collections. Although it doesn't grow in France, we make sure that its origin is controlled and responsibly managed:

- The teak we use comes exclusively from **Indonesia**, sourced from certified **plantations managed in a sustainable way**.
- Whenever possible, we choose **French or European suppliers** to reduce transport distances and support local expertise.
- We ask all our partners to ensure safe and fair **working conditions**, exceeding current standards.

These principles guide our decisions and motivate us to keep improving every day.

## Nos matières

### L'importance du bon matériau

Un mobilier de qualité commence toujours par le **bon matériau**.

Au fil du temps, nous avons appris à associer **le bois, l'aluminium, la toile technique, la céramique** et d'autres matériaux performants pour concevoir des produits confortables, fiables et agréables à vivre.

Nous collaborons avec des **fournisseurs de confiance**, reconnus pour leur sérieux et la constance de leur qualité.

Cette exigence partagée nous permet de vous proposer des collections pensées pour durer et accompagner votre quotidien, en toute simplicité.

### Our materials

#### The Importance of the Right Material

Quality furniture always begins with the **right material**.

Over time, we've learned how to combine **wood, aluminum, technical fabrics, ceramic**, and other high-performance materials to create pieces that are comfortable, reliable, and pleasant to live with.

We work with **trusted suppliers**, recognized for their professionalism and consistent quality.

This shared commitment allows us to offer collections designed to last and to be part of your everyday life, simply and naturally.

## Aluminium

Tube aluminium extrudé, peinture poudre polyester cuite au four. Pas d'entretien particulier.

Extruded aluminium tube, painting with powder coating. No maintenance required.

## Acier inoxydable

Pièces visseries, barres de tension de toiles Sling ou batyline en acier inoxydable. Demande un entretien régulier dès l'apparition de tâches d'oxydation, de préférence avec notre produit STARBRITE Ref NET08NP

STAINLESS STEEL  
Spare parts (screw, tension bars for Sling or Batyline fabrics) in stainless steel. Regular maintenance when appearance of oxidation tasks. We rather recommend our STARBRITE ref. NET08NP Chrome and stainless polish.

## HPL : Stratifié haute pression

Se compose d'une feuille décor imprimée ou teintée dans la masse, imprégnée de résine mélamine, et d'une couche de support par empilage de papier krafts imprégnés de résine phénolique. Facile d'entretien, résiste aux rayures. Tous les matériaux s'altèrent aux UV, le HPL n'échappe pas à cette règle. Notre conseil : si vous avez acheté une table extensible avec un revêtement en HPL, et que cette dernière reste exposée toute l'année aux UV, laissez la table grande ouverte pour éviter une différence de couleur entre la rallonge et les plateaux. Traitement possible avec notre kit HPL.

High Pressure decorative Laminates (HPL), consisting of a surface of decorative paper(s) impregnated with aminoplastic resins and a core made of layers of kraft paper impregnated with phenolic thermosetting resins. All the layers are bonded together with simultaneous application of heat and high specific pressure to obtain a homogeneous non-porous material with increased density. Easy maintenance and cleaning, no special maintenance required. Scratch resistant. Our advise : if you buy an extending table with a HPL top and if the table stay all year long exposed at the UV's, keep the table open to avoid discoloration between extension and tops. Treatment possible with our kit HPL.

## Toile Sunbrella®



Tissu d'extérieur en acrylique teinté dans la masse. Excellente tenue des couleurs dans le temps. Bonne résistance à la déchirure et à l'abrasion. Bonne résistance à l'eau - Facile d'entretien. Pensez à hiverner vos coussins.

Outdoor acrylic fabric dyed. Excellent colors in time. Good resistance to tearing and abrasion Good resistance to water. Easy maintenance Think to store your cushions during winter time.

## Toile Olefin

Toile Olefin 100% polypropylène déperlante, résiste aux UV et aux intempéries Pensez à hiverner vos coussins.

Olefin fabric, 100% polypropylen, water repelent, UV and all weather resistant. Think to store your cushions during winter time.

## Corde Olefin

Cette corde en fibre synthétique est adaptée pour l'extérieur. Sa structure résistante aux intempéries, imputrescible et à la lumière du soleil (UV) reste résistante au fil des saisons. Nettoyage simple à l'eau savonneuse.

Olefin rope, this synthetic fiber rope is suitable for outdoor use. Its weatherproof, rot-proof and sunlight (UV) resistant structure remains strong through the seasons. Easy to clean with soapy water.

## Teck massif de plantation

Notre teck massif est issu de culture raisonnée.  
Essence : Tectona Grandis  
Our solid teak comes from reasoned culture.  
Plantation teak. Species : Tectona Grandis



## Duratek®

Protection longue durée de votre teck en extérieur ! Finies les contraintes d'un entretien fastidieux !

Le teck est préalablement soumis à un décapage mécanique qui lui donne un aspect vieilli et veiné. Puis, afin de le protéger durablement contre les UV, les intempéries et les taches domestiques (gras, café, vins, etc...), il subit un traitement exclusif, par application de 6 couches successives, lui conférant ce fini grisé très contemporain. Entretien : Ne pas huiler. Nettoyage à l'eau savonneuse

DURATEK® : The ultimate protection for your outdoor teak furniture. Say goodbye to teak maintenance once and for all! Our teak is first vigorously brushed to obtain a textured and seasoned finish. Then, after a first coat of waterproofing primer, five coats of grey finish are applied. This process protects the wood against the weather, UVs and various stains such as wine, coffee or oil. The grey color we have chosen emphasizes our contemporary chic collections. Maintenance : Do not oil. Clean with soapy water

## Céramique

Nos dalles céramiques sont fabriquées en Italie. Elles se composent uniquement de matières premières naturelles (argile, sable quartzifère, substances vitreuses...) mélangées à l'eau et cuites à haute température pour des dalles d'un niveau technique et esthétique exceptionnel. Hautes résistances aux UV, au gel et aux produits chimiques, la céramique est un matériau extrêmement facile et rapide à nettoyer. Elle peut être lavée à l'eau chaude additionnée d'un simple détergent neutre, facile à trouver dans le commerce.

Our ceramic tiles are made in Italy. They are made only of natural raw materials (clay, quartz sand, vitreous substances...) mixed with water and fired at high temperature for tiles of an exceptional technical and aesthetic level. Highly resistant to UV, frost and chemicals, ceramic is an extremely easy and quick material to clean. It can be washed with hot water and a simple neutral detergent, easily available in stores.

## Toile Ateja

Polychlorure de vinyle. Toile perforée lissée; résistante aux intempéries et facile d'entretien (eau savonneuse)

Polyvinyl chloride : Weaved drilled web. No maintenance required, use wet cloth or soapy water.

## Toile Batyline®



Toile perforée tissée en fil polyester gainée de PVC (Polychlorure de Vinyte) de marque BATYLINE.  
Entretien : Eau avec ou sans détergent · Notre produit STARBRITE réf. NETDFPT Nettoyant pour batyline 0,65L

Batyline fabric is made out of polyester thread with composite girdle No maintenance required : use wet cloth or soapy water. We rather recommend our STARBRITE ref NETDFPT Batyline cleaner 0,65 L.

\* Teck à la finition Duratek®. Duratek® finish Teak.



## MATÉRIAUX / MATERIALS

### TOILE / SLING

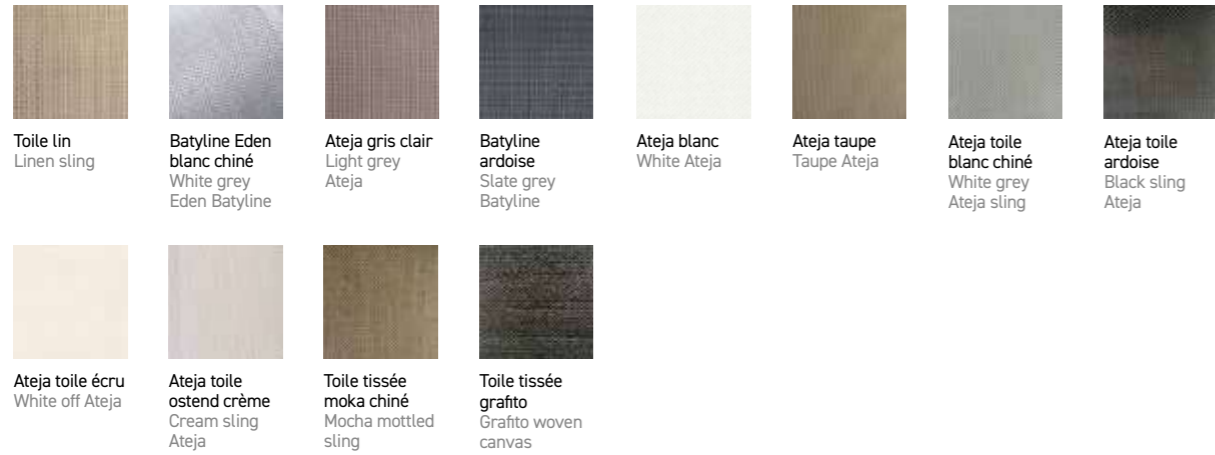

**Toile lin**  
Linen sling  
**Batyline Eden blanc chiné**  
White grey Eden Batyline  
**Ateja gris clair**  
Light grey Ateja  
**Batyline ardoise**  
Slate grey Batyline  
**Ateja blanc**  
White Ateja  
**Ateja taupe**  
Taupe Ateja  
**Ateja toile blanc chiné**  
White grey Ateja sling  
**Ateja toile ardoise**  
Black sling Ateja

**Ateja toile écru**  
White off Ateja  
**Ateja toile ostend crème**  
Cream sling Ateja  
**Toile tissée moka chiné**  
Mocha mottled sling  
**Toile tissée grafito**  
Grafito woven canvas

### BOIS & VERRE / WOOD & GLASS

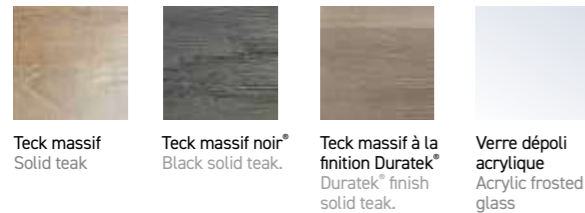

**Teck massif**  
Solid teak  
**Teck massif noir®**  
Black solid teak.  
**Teck massif à la finition Duratek®**  
Duratek® finish solid teak.  
**Verre dépoli acrylique**  
Acrylic frosted glass

### PIERRE / STONE

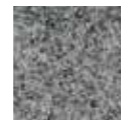

**Granite**  
Granit

### CORDE & WICKER / ROPE & WICKER

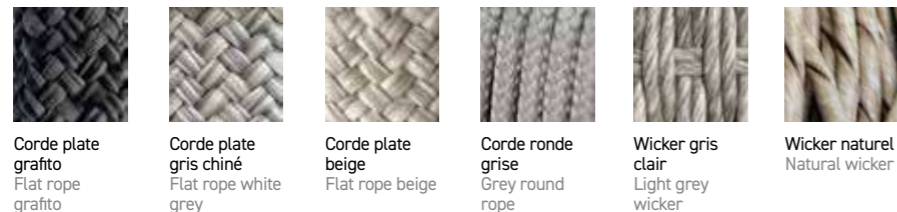

**Corde plate grafito**  
Flat rope grafito  
**Corde plate gris chiné**  
Flat rope white grey  
**Corde plate beige**  
Flat rope beige  
**Corde ronde grise**  
Grey round rope  
**Wicker gris clair**  
Light grey wicker  
**Wicker naturel**  
Natural wicker

### PEINTURE / PAINT

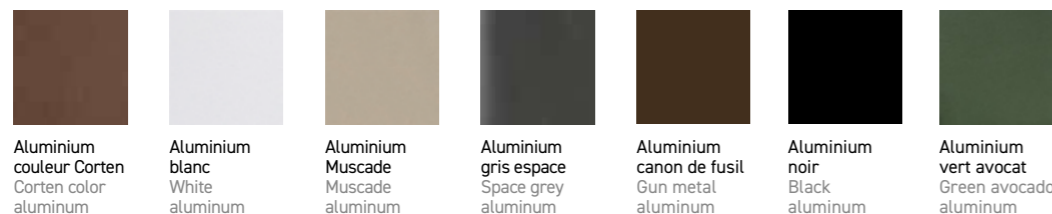

**Aluminium couleur Corten**  
Corten color aluminum  
**Aluminium blanc**  
White aluminum  
**Aluminium Muscade**  
Muscade aluminum  
**Aluminium gris espace**  
Space grey aluminum  
**Aluminium canon de fusil**  
Gun metal aluminum  
**Aluminium noir**  
Black aluminum  
**Aluminium vert avocat**  
Green avocado aluminum

## MATÉRIAUX / MATERIALS

### TISSU / FABRIC



**Ateja copacobana gris chiné**  
White grey Copacobana Ateja canvas  
**Ateja gris clair**  
Light grey Ateja  
**Sunbrella® natté gris clair**  
Natte light grey Sunbrella®  
**Sunbrella® natté grafito**  
Natte grafito Sunbrella®  
**Sunbrella® lopi marble**  
Marble Sunbrella® Lopi  
**Sunbrella® deauve**  
Deauve Sunbrella®  
**Agora Panama fossil**  
Fossil Panama Agora  
**Sunbrella® raffa**  
Raffa Sunbrella®

**Ateja La concha taupe chiné**  
Heaver taupe La concha Ateja  
**Ateja Bay chiné**  
Bay mottled grey Ateja  
**Ateja La concha terracotta**  
La concha terracotta Ateja  
**Sunbrella® lopi gris**  
Grey Sunbrella® Lopi  
**Sunbrella® Tundra**  
Tundra Sunbrella®

### CERAMIQUE / CERAMIC

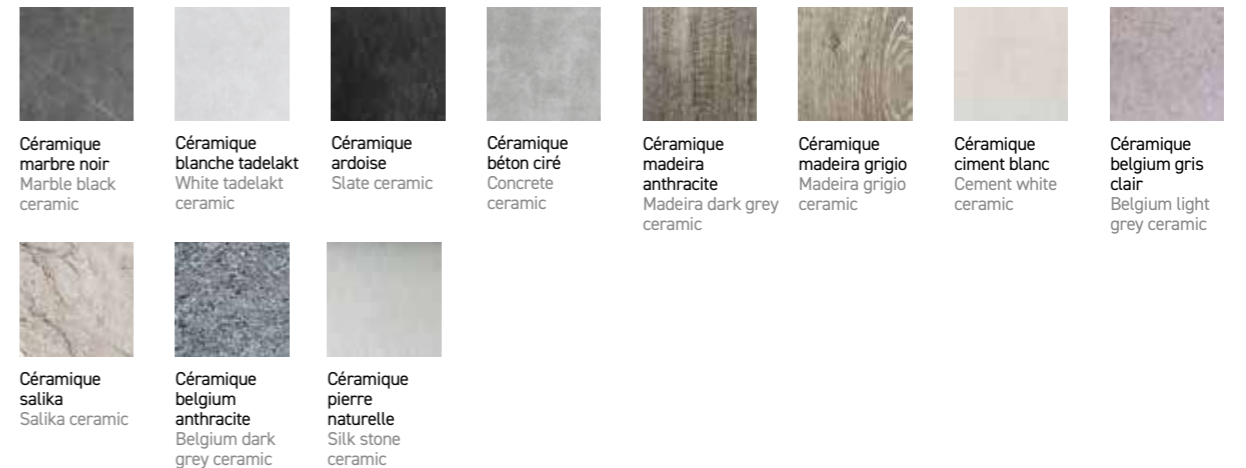

**Céramique marbre noir**  
Marble black ceramic  
**Céramique blanche tadelakt**  
White tadelakt ceramic  
**Céramique ardoise**  
Slate ceramic  
**Céramique béton ciré**  
Concrete ceramic  
**Céramique madeira anthracite**  
Madeira dark grey ceramic  
**Céramique madeira grigio**  
Madeira grigio ceramic  
**Céramique ciment blanc**  
Cement white ceramic  
**Céramique belgium gris clair**  
Belgium light grey ceramic

**Céramique salika**  
Salika ceramic  
**Céramique belgium anthracite**  
Belgium dark grey ceramic  
**Céramique pierre naturelle**  
Silk stone ceramic

### HPL / HPL



**HPL béton ciré**  
White wash Concrete HPL  
**HPL ardoise**  
Slate grey HPL  
**HPL céramique grise**  
Drey ceramic HPL  
**HPL céramique lin**  
Lin ceramic HPL

### TOILE PARASOL / UMBRELLA COVER



**Toile olefin taupe 220 gr**  
Taupe  
**Toile olefin cappuccino 260 gr**  
Cappuccino  
**Toile olefin écru 220 gr**  
Off white  
**Toile olefin blanche 220 gr**  
White  
**Toile olefin grise 220 gr**  
Grey  
**Toile olefin anthracite 220 gr**  
Black

## General terms of sale between professionals

### 1 - General

These conditions are valid vis-à-vis those purchasers from Industry, Trade and various other lines of business.

Any order implies total acceptance of these general terms of business (GTB) from the purchaser without reserve.

They will prevail all contrary provisions that could appear on the order forms, general terms of purchase or any other document from the purchaser. Any derogation from these GTB must be expressly accepted by SEL.

### 2 - Orders

Any order placed must be confirmed in return by SEL - LES JARDINS to engage our commitment.

Any order placed directly through one of our representatives involves our commitment only if it is confirmed by our sales department.

Any modification, or cancellation, even partially, must be agreed previously by our company.

Any additional order following an order confirmation will be considered as a new order.

**Special order:** in case of special order (special production), a minimum of 50% of downpayment will be required when order will be placed. In case of cancelation, downpayment will be held by vendor.

**Container order:** a minimum of 50% of downpayment will be required when order will be placed. In case of cancelation, downpayment will be held by vendor.

### 3 - Prices

Prices are quoted EXW DOUAI our warehouse (59500). Any sale is based on prices and general terms confirmed in our order confirmation. Prices and technical description describe in our general catalogue are only for information.

We may revise our prices at any time in function of economic changes or increases due to raw materials or transportation costs.

The valid prices are the one shown on the order confirmation at the date of order. Our prices are available upon request.

### 4 - Stock

Our products are sold according to the stock available.

Our company reserves the right to cancel a model from the collection at any time and without notice.

### 5 - Delivery time

The delivery time mentioned in our commercial documents is for information only and in good faith. Therefore, if any delay occurs, the purchaser has no right to refuse the goods in case of fortuitous events or in case of major force, purchaser can not cancel his order.

### 6 - Transport

Our goods are sold ex-warehouse. Even in the case of carriage-paid invoicing, goods travel at the consignee's risk. From a total order of €2,000 excluding VAT per delivery, shipment is made carriage paid to Metropolitan France. (Exclusively reserved for CHR retailers and professionals). For all orders between 1500 €/HT and 1 999 €/HT net invoiced, an additional charge of 7% of the invoice amount excluding VAT will be invoiced, and a flat-rate charge of 100 €/HT for all orders below 1500 €/HT. For islands: Corsica, Ile de Ré, Ile d'Oléron, Belle-Ile-En-Mer, etc... transport will be invoiced in addition. For export orders, goods will be sold EXW from our warehouse in DOUAI (59500) or FOB from our factories.

### 6 -1 - Accessibility of delivery site - bulk :

Additional charges will be applied depending on the accessibility of the delivery site and the size or weight of the goods. Our delivery rates are based on normal access conditions for national transport (minimum 19 T truck).

The customer must ensure in advance that the goods are accessible and that delivery can be made under these conditions. Should this not be the case, the purchaser will bear all related costs, including those associated with a second delivery with adapted vehicle, personnel and equipment, and will in no way constitute grounds for order cancellation. Any absence on the day of delivery without prior notification by e-mail to our services 48 hours in advance will be subject to invoicing for an additional delivery. Invoicing for the first delivery will remain the responsibility of the purchaser.

### 7 - Reception - Claims - Returns

The consignee must check the number of packages, describe precisely if any products or cartons box are damaged (ref, number of package concerned), if there are missing goods (ref + quantity), etc... in the presence of the delivery man.

Any claim must be mentioned on the transport receipt and confirmed to the forwarder by recorded delivery letter with acknowledgement receipt within two open days. A copy must be sent to us within the same time.

Without any claim within this delay, goods will not be replaced or refunded.

No credit note or product replacement will be accepted in case of claim declared more than

2 weeks after the delivery date.

No product return will be accepted without our agreement. Return will be only accepted if goods in their original packing, at consignee's charge, and mentioning our bill of return number confirmed by our sales department.

Product return in carriage forward will be refused.

### 8 - Terms of Payment:

The total amount of the invoice needs to be paid at the deadline shown on the invoice. Any derogation must get SEL written acceptance.

For advance payment, within 10 days following delivery, we offer a 1 % discount,

applicable only to professionals.

Any late payment shall bear interest in accordance with Article L441-6 of the French Commercial Code at 3 times the average rate applied by the European Central Bank to its most recent refinancing operation plus 10% plus a flat-rate indemnity for collection costs of €40 excluding VAT (Article D441-5 of the French Commercial Code).

### 9 - Reserve of ownership

The goods are property of SEL up to the fulfillment of all commitments

of the contractual relation. In spite of this clause, the responsibility of the goods is transferred to the purchaser as soon as the goods are given to the forwarder. The client has to take good care of the goods which are under retention of property, to inform the supplier immediately in writing about each change of location and interventions of a third party. If the goods are supplied to a third party according to the intended purpose, the client has to obligate this third party to observe the retention of property in accordance with the provisions mentioned above. In this case of disregard of the aforementioned determined liabilities of the client, SEL has the right to withdraw from the Further legal procedures might follow.

### 10 - Guarantee

SEL warrants to the purchaser that our furniture and all its parts and components are free of defects in material and workmanship.

Our two years warranty is limited to the replacement of furniture parts and components. This warranty does not cover defects caused by improper assembly, defects due to modifications by the purchaser, intentional damage, misuse, abuse or negligence, normal wear and tear due to age and labor or assembly costs.

No product replacement will be done if a defective spare part can be replaced.

Spare parts replacement will be carried out by the final end customer or by retailer.

Guarantee exclusions:

- With time, natural teak turns grey. Cracks can also appear on its surface. Adequate treatments are available to ensure that furniture keeps its original appearance.

- Rust on stainless steel spare parts (sun lounger legs, fitting kits, tension bars, cables, etc.) are not covered near sea shore or in confined or chlorinated areas

- Domestic stains on HPL top.

- Umbrella ribs are out of the present guarantee.

- End of collection items are not replaced or refunded.

### 11 - Spare parts

All our spare parts are on stock for a 2 years period after product stop.

### 12 - Place of performance and jurisdiction

All the disputes and eventual claims to interpretation, execution or carrying out of an order can only be brought to the court of the city where our head office is located.

### 13 - Eco-Mobilier

Eco-Mobilier is a nonprofit organization accredited by the French government. The funds collected are fully allocated to financing the gathering and recycling of old furniture being trashed.

It includes furniture and furnishings such as seating, dining, bedding, shelving and counter tops.

From May 1st onwards, one shall label all furniture sold by any appropriate means with the following information: price, eco-mobilier additional fee, and total cost price + fee. This cost breakdown shall appear at the bottom of your receipt.

This new tax will be charged to the end user.

Warning: The eco-fee being set by Eco-Mobilier, SEL-LES JARDINS

shall charge it to its clients and it can be changed without prior notice.

Les Jardins® is registered in the National Register of Marketers under number FR 019011. This number guarantees that Les Jardins®, by joining Ecomobilier, is in compliance with the regulatory obligations incumbent upon it in application of article L541- 10-6 of the Environmental Code.

## Conditions générales de vente entre professionnels

**Le montant de l'éco-participation est susceptible d'évoluer en cours d'année.**

### Article 1 - Champ d'application des conditions générales de ventes

Les présentes conditions s'appliquent aux ventes, aux acheteurs ayant une activité professionnelle. Toutes commandes impliquent l'adhésion entière et sans réserve à nos conditions qui prévalent sur toutes stipulations pouvant figurer sur tout document émanant de l'acheteur.

Toute dérogation doit être acceptée par SEL.

### Article 2 - Commande

Toute commande doit pour engager notre société, faire l'objet d'une confirmation de commande écrite de notre part. L'acceptation par nos clients, de nos confirmations de commande, implique leur adhésion aux présentes conditions générales de vente.

La commande passée par l'intermédiaire d'un de nos représentants ne nous engage que si elle a été confirmée par notre service commercial. Une modification, une annulation même partielle ne peut intervenir sans notre accord.

Tout complément de commande postérieur à une confirmation de commande, constitue une nouvelle commande.

**Commande spéciale :** dans le cas d'une commande spéciale (fabrication spéciale), un acompte à minima de 50% sera demandé au moment de la validation de la commande.

En cas d'annulation, les acomptes resteront au profit du vendeur.

**Commande container :** un acompte à minima de 50% sera demandé au moment de la validation de la commande. En cas d'annulation, les acomptes resteront au profit du vendeur.

### Article 3 - Conditions de prix

Toutes les ventes sont conclues sur la base du prix et des conditions de prix mentionnés sur notre confirmation de commande. Nos prix et renseignements contenus dans notre catalogue sont fournis à titre indicatif. Seuls les prix et renseignements figurant sur nos bons de commande engage la responsabilité de notre société.

En effet nos prix sont susceptibles d'être modifiés et indexés en fonction des hausses des matières premières et des coûts de transport.

### Article 4 - Stock

Nos produits sont vendus dans la limite des stocks disponibles. Nous nous réservons le droit à tout moment et sans préavis de supprimer un modèle de notre collection.

### Article 5 - Délai

Les délais de livraison sont donnés à titre indicatif, les retards éventuels ne donnent pas droit à l'acquéreur d'annuler sa commande, de refuser la marchandise ou de réclamer des dommages intérêts, notamment dans le cas d'une situation de force majeure. Par conséquent, la société est libérée de son obligation de délai de livraison pour tout cas fortuit et/ou de force majeure, sans annulation possible de la part de l'acquéreur.

### Article 6 - Transport

Nos marchandises sont vendues départ de nos entrepôts. Même en cas de facturation franco, les marchandises voyagent aux risques et périls du destinataire. A partir d'un total de commande de 2 000 € HT par livraison, l'expédition est faite franco de port France Métropolitaine. (Exclusivement réservé aux revendeurs et professionnels CHR). Pour toute commande comprise entre 1500 €/HT et 1 999 €/HT net facturée, il sera facturé en sus 7 % du montant HT de la facture, et un montant forfaitaire de 100 €/HT pour toute commande inférieure à 1500 €/HT. Pour les îles : Corse, îles de Ré, Ile d'Oléron, Belle-Ile-En-Mer, etc... le transport sera facturé en sus. Pour toute commande export la marchandise sera vendue au départ (EXW) de notre entrepôt de DOUAI (59500) ou FOB depuis nos usines.

### 6-1 Accessibilité du lieu de livraison - encombrement :

Des frais supplémentaires seront appliqués en fonction de l'accessibilité du lieu de livraison de la marchandise, et de l'encombrement des marchandises ou de leur poids. Nos tarifs de livraison s'entendent pour des conditions normales d'accès par des transports nationaux (camion minimum 19 T).

En cas d'accès difficile nécessitant l'utilisation d'un véhicule de livraison de gabarit réduit (type petit camion), un supplément forfaitaire de 150 € HT sera appliqué aux frais de livraison. La qualification d'« accès difficile » est appréciée par le transporteur ou notre service logistique.

Le client doit s'assurer au préalable de l'accessibilité et de réalisation de la livraison dans ces conditions. Dans le cas contraire, l'acheteur supportera tous les frais afférents y compris ceux attachés avec une seconde livraison avec véhicule, personnel et matériel adapté et ne constituera en rien un motif d'annulation de commande.

Toute absence le jour de la livraison sans information par mail auprès de nos services 48h00 au préalable fera l'objet d'une facturation d'une livraison supplémentaire.

La facturation de la première livraison restera à l'entière charge de l'acheteur.

### Article 7 - Réception - Réclamations - Retour marchandises

Il appartient au destinataire, en présence du livreur, de constater les retards, décrire l'avarie précise sur les produits/cartons, les manquants éventuels (ref et quantités), préciser si la palette a été déconditionnée ou livrée sans film de protection ou bandes de garantie. Toute réclamation devra être formulée sur le récépissé du transporteur et confirmée à ce dernier par lettre recommandée avec AR dans les 48 H ouvrables suivant la réception. Une copie devra nous être transmise dans ce délai. A défaut de réclamation dans ce délai, les marchandises ne seront ni échangées, ni remboursées. Aucun avoir ou échange ne sera effectué en cas de litige déclaré plus de 15 jours après la date de réception effective des marchandises.

Aucun retour de marchandise ne peut être effectué sans notre accord préalable écrit.

Un retour ne sera accepté que si les marchandises sont retournées aux frais du client, dans leur emballage d'origine, et avec mention du numéro de retour attribué par nos services.

Les produits retournés en port dû ou en contre remboursement seront refusés.

### Article 8 - Conditions de règlement

Toutes nos marchandises sont payables comptant avant expédition ou en contre-remboursement à la livraison sauf accord écrit.

Pour tout paiement comptant sous 10 jours date de facture, un escompte de 1 % sera effectué, applicable uniquement aux professionnels.

Tout retard de paiement porte intérêt selon l'article L441-6 du Code de Commerce à 3 fois le taux moyen appliqué par la Banque Centrale Européenne à son opération de refinancement la plus récente majoré de 10% avec en sus une indemnité forfaitaire pour frais de recouvrement de 40 € HT (article D441-5 du Code de Commerce).

### Article 9 - Réserve de propriété

Les marchandises vendues restent notre propriété jusqu'à la disponibilité pour nous de l'intégralité du montant facturé. Nonobstant cette clause, la charge des risques est transférée à l'acquéreur dès la remise des marchandises au transporteur. L'acheteur est autorisé à revendre les marchandises à condition d'avoir réglé intégralement le vendeur ou de communiquer au vendeur le jour même de la revente, copie du contrat de revente, identité de l'acquéreur, conditions de paiement. Jusqu'à complet paiement, l'acheteur prendra les dispositions nécessaires pour faire apparaître aux tiers la propriété de SEL. L'acheteur déclare en outre, irrévocablement céder au vendeur, à concurrence du montant de sa dette envers celui-ci, ses droits de créance sur son acquéreur, garantir au vendeur la solvabilité actuelle et future de cet acquéreur et s'engage à payer lui-même à défaut de celui-ci.

Si les marchandises sont destinées à des ventes successives, l'acheteur s'engage à porter et faire porter une clause identique à celle-ci en faveur de SEL dans les différents contrats, l'acheteur demeurant garant.

SEL pourra reprendre toutes marchandises impayées, cette reprise n'étant pas exclusive d'autres procédures.

### Article 10 - Garantie

Nos produits sont garantis durant deux années contre tout vice de fabrication indépendamment de l'application de la garantie légale contre les vices cachés prévue par l'article 1641 du Code Civil et dans la limite où des soins convenables devront être pris lors de leur stockage, montage et sous réserve d'une utilisation et d'un entretien normal. Attention, aucun échange complet d'un produit ne sera effectué, si la pièce détériorée peut être remplacée. Le remplacement s'effectuera par le revendeur ou le client final. Seule la garantie vice de fabrication s'applique sur nos produits à compter de la date d'achat par le client final.

Sont expressément exclus de la présente garantie :

- Les évolutions d'aspect du teck liées à son vieillissement, le teck étant un matériau vivant, il peut apparaître des fissures à sa surface.

- La corrosion des pièces inox (câble de tension, béquille de bain de soleil, visserie, barres de tension, ...) en front de mer ou dans un environnement chloré et confiné. L'inox nécessite un entretien régulier, dès l'apparition de taches d'oxydation, celle-ci doivent être nettoyées

- Les taches domestiques sur les revêtements de tables en HPL

- Les baleines de parasol sont exclues de la présente garantie

- Les produits Fin de série ne font l'objet d'aucun avoir, SAV, reprise ou échange

### Article 11 - Pièces détachées

Nos pièces détachées (d'usure ou de casse) sont gérées en stock jusqu'à 2 ans après la date d'arrêt du produit concerné.

### Article 12 - Litiges

A défaut d'un accord amiable sur les éventuels différends, ceux-ci relèvent exclusivement de la compétence du tribunal de commerce de notre siège social.

### Article 13 - Eco participation

Eco-mobilier est une société sans but lucratif, agréée par les pouvoirs publics. Les sommes perçues seront intégralement affectées au financement de la collecte et du recyclage des déchets d'ameublement ménagers.

Les produits concernés sont les meubles et éléments d'ameublement qui offrent une assise, un couchage, du rangement, un plan de pose ou de travail. A partir du 1<sup>er</sup> Mai 2013, vous devrez indiquer, par voie de marquage, d'étiquetage, d'affichage ou par tout autre procédé approprié, pour tous les meubles que vous vendez, dont les meubles de jardin, en plus du prix, le montant de l'éco-participation Mobilier et le total prix + éco-participation. Ce triple affichage devra aussi paraître au pied de la facture et du ticket de caisse. Cette nouvelle taxe devra donc être répercutée à l'identique auprès du consommateur final.

Attention : L'éco-participation étant fixée par Eco-Mobilier, SEL - LES JARDINS sera dans l'obligation de répercuter à sa clientèle, en totalité et sans aucun préavis, toute modification intervenant dans le montant de celle-ci.

Les Jardins® est enregistré au Registre national des metteurs sur le marché d'éléments d'ameublement sous le numéro FR 019011. Ce numéro garantit que Les Jardins®, en adhérant à Ecomobilier, est en conformité avec les obligations réglementaires qui lui incombent en application de l'article L541-10-6 du Code de l'Environnement.

## Tarif valable du 01.09.2025 au 31.08.2026

Franco de port France métropole pour toute commande supérieure ou égale à 2 000 € HT pour du mobilier livré démonté.

Franco de port France métropole pour toute commande de luminaire solaire (sans mobilier) supérieure ou égale à 1 000 € HT

SEL - 1115 rue René Descartes - ZAC du Parc de la Duranne - 13100 Aix-en-Provence - France

Tél. (33) 04 42 90 45 30 - Fax (33) 04 42 90 70 11 - Email : [contact@lesjardins.com](mailto:contact@lesjardins.com) - [www.lesjardins.com](http://www.lesjardins.com)

RC AIX 2002 B 1217 - Siret 354 044 257 00054 - APE 516 K - TVA FR 49354044257 - SAS au capital social de 350 000 Euros



<https://quefairedemesdechets.fr>



LES JARDINS®  
1115 rue René Descartes - ZAC du Parc de la Duranne  
13100 Aix-en-Provence - France  
Tél. (33) 04 42 90 45 30 - Fax (33) 04 42 90 70 11

**SHOWROOM PROFESSIONNEL AIX-EN-PROVENCE**